

# PS3.1

| DICOM PS3.1 ~~2018b~~2018c - Introduction and Overview

**PS3.1: DICOM PS3.1 ~~2018b~~2018c - Introduction and Overview**

Copyright © 2018 NEMA

A DICOM® publication

# Table of Contents

Notice and Disclaimer .....	7
Foreword .....	9
1. Scope and Field of Application .....	11
1.1. Scope of DICOM .....	11
1.2. Field of Application .....	11
1.3. History .....	11
1.4. Principles .....	12
1.4.1. Global Applicability and Localization .....	12
1.4.2. Continuous Maintenance .....	12
1.4.3. Information Objects and Unique Object Identification .....	13
1.4.4. Conformance .....	13
1.4.5. Consistency of Information Model .....	13
2. Normative References .....	15
3. Definitions .....	17
4. Symbols and Abbreviations .....	19
5. The DICOM Communication Model .....	21
6. Overview of The Content of The DICOM Standard .....	23
6.1. Document Structure .....	23
6.2. PS3.2: Conformance .....	23
6.3. PS3.3: Information Object Definitions .....	25
6.4. PS3.4: Service Class Specifications .....	25
6.5. PS3.5: Data Structure and Semantics .....	25
6.6. PS3.6: Data Dictionary .....	26
6.7. PS3.7: Message Exchange .....	26
6.8. PS3.8: Network Communication Support For Message Exchange .....	26
6.9. PS3.9: Retired (formerly Point-to-point Communication Support For Message Exchange) .....	27
6.10. PS3.10 Media Storage and File Format .....	27
6.11. PS3.11: Media Storage Application Profiles .....	28
6.12. PS3.12: Storage Functions and Media Formats For Data Interchange .....	29
6.13. PS3.13: Retired (formerly Print Management Point-to-point Communication Support) .....	29
6.14. PS3.14: Grayscale Standard Display Function .....	29
6.15. PS3.15: Security and System Management Profiles .....	29
6.16. PS3.16: Content Mapping Resource .....	30
6.17. PS3.17: Explanatory Information .....	30
6.18. PS3.18: Web Services .....	30
6.19. PS3.19: Application Hosting .....	30
6.20. PS3.20: Imaging Reports using HL7 Clinical Document Architecture .....	31
6.21. PS3.21: Transformations between DICOM and other Representations .....	31
7. Referencing The DICOM Standard .....	33



---

## List of Figures

5-1. General Communication Model .....	22
6.2-1. Construction Process for a Network Conformance Claim .....	24
6.2-2. Construction Process for a Media Conformance Claim .....	24
6.10-1. DICOM Media Communication Model .....	28
6.11-1. Relationship Between an Application Profile and Parts of DICOM .....	29
6.19-1. Interface Between a Hosted Application and a Hosting System .....	30
6.19-2. Illustration of Platform Independence via the Hosted Application .....	31



# Notice and Disclaimer

The information in this publication was considered technically sound by the consensus of persons engaged in the development and approval of the document at the time it was developed. Consensus does not necessarily mean that there is unanimous agreement among every person participating in the development of this document.

NEMA standards and guideline publications, of which the document contained herein is one, are developed through a voluntary consensus standards development process. This process brings together volunteers and/or seeks out the views of persons who have an interest in the topic covered by this publication. While NEMA administers the process and establishes rules to promote fairness in the development of consensus, it does not write the document and it does not independently test, evaluate, or verify the accuracy or completeness of any information or the soundness of any judgments contained in its standards and guideline publications.

NEMA disclaims liability for any personal injury, property, or other damages of any nature whatsoever, whether special, indirect, consequential, or compensatory, directly or indirectly resulting from the publication, use of, application, or reliance on this document. NEMA disclaims and makes no guaranty or warranty, expressed or implied, as to the accuracy or completeness of any information published herein, and disclaims and makes no warranty that the information in this document will fulfill any of your particular purposes or needs. NEMA does not undertake to guarantee the performance of any individual manufacturer or seller's products or services by virtue of this standard or guide.

In publishing and making this document available, NEMA is not undertaking to render professional or other services for or on behalf of any person or entity, nor is NEMA undertaking to perform any duty owed by any person or entity to someone else. Anyone using this document should rely on his or her own independent judgment or, as appropriate, seek the advice of a competent professional in determining the exercise of reasonable care in any given circumstances. Information and other standards on the topic covered by this publication may be available from other sources, which the user may wish to consult for additional views or information not covered by this publication.

NEMA has no power, nor does it undertake to police or enforce compliance with the contents of this document. NEMA does not certify, test, or inspect products, designs, or installations for safety or health purposes. Any certification or other statement of compliance with any health or safety-related information in this document shall not be attributable to NEMA and is solely the responsibility of the certifier or maker of the statement.





# Foreword

The DICOM Standards Committee is an independent, international standards development organization comprising biomedical professional societies whose specialties include the use of medical imaging, manufacturers of medical imaging equipment and related information systems, and government agencies, trade associations, and other standards development organizations with an interest in standardization of medical imaging information and related data. Membership is open to all organizations with a material interest in the work of the Committee. The Committee collaborates closely with other standards development organizations in the fields of Healthcare Informatics and Electrical Equipment in Medical Practice. The Secretariat of the Committee is the National Electrical Manufacturers Association and its Medical Imaging and Technology Alliance division.

The principal product of the Committee is this Standard, Digital Imaging and Communications in Medicine (DICOM).

This DICOM Standard was developed according to the procedures of the DICOM Standards Committee.

The DICOM Standard is structured as a multi-part document using the guidelines established in [ISO/IEC Directives, Part 2].

The Standard is published as NEMA Standard PS3, and its Parts are identified by the numbering of the NEMA publication (PS3.1, PS3.2, etc.).

DICOM® is the registered trademark of the National Electrical Manufacturers Association for its standards publications relating to digital communications of medical information, all rights reserved.

HL7® and CDA® are the registered trademarks of Health Level Seven International, all rights reserved.

SNOMED®, SNOMED Clinical Terms®, SNOMED CT® are the registered trademarks of the International Health Terminology Standards Development Organisation (IHTSDO), all rights reserved.

LOINC® is the registered trademark of Regenstrief Institute, Inc, all rights reserved.



# 1 Scope and Field of Application

PS3.1 provides an overview of the entire Digital Imaging and Communications in Medicine (DICOM) Standard. It describes the history, scope, goals, and structure of the Standard. In particular, it contains a brief description of the contents of each part of the Standard.

## 1.1 Scope of DICOM

Digital Imaging and Communications in Medicine (DICOM) is the standard for the communication and management of medical imaging information and related data.

The DICOM Standard facilitates interoperability of medical imaging equipment by specifying:

- For network communications, a set of protocols to be followed by devices claiming conformance to the Standard.
- The syntax and semantics of Commands and associated information that can be exchanged using these protocols.
- For media communication, a set of media storage services to be followed by devices claiming conformance to the Standard, as well as a File Format and a medical directory structure to facilitate access to the images and related information stored on interchange media.
- Information that must be supplied with an implementation for which conformance to the Standard is claimed.

The DICOM Standard does not specify:

- The implementation details of any features of the Standard on a device claiming conformance.
- The overall set of features and functions to be expected from a system implemented by integrating a group of devices each claiming DICOM conformance.
- A testing/validation procedure to assess an implementation's conformance to the Standard.

## 1.2 Field of Application

The DICOM Standard pertains to the field of Medical Informatics. Within that field, it addresses the exchange of digital information between medical imaging equipment and other systems. Because such equipment may interoperate with other medical devices and information systems, the scope of this Standard needs to overlap with other areas of medical informatics. However, the DICOM Standard does not address the breadth of this field.

This Standard has been developed with an emphasis on diagnostic medical imaging as practiced in radiology, cardiology, pathology, dentistry, ophthalmology and related disciplines, and image-based therapies such as interventional radiology, radiotherapy and surgery. However, it is also applicable to a wide range of image and non-image related information exchanged in clinical, research, veterinary, and other medical environments.

This Standard facilitates interoperability of systems claiming conformance in a multi-vendor environment, but does not, by itself, guarantee interoperability.

## 1.3 History

With the introduction of computed tomography (CT) followed by other digital diagnostic imaging modalities in the 1970's, and the increasing use of computers in clinical applications, the American College of Radiology (ACR) and the National Electrical Manufacturers Association (NEMA) recognized the emerging need for a standard method for transferring images and associated information between devices manufactured by various vendors. These devices produce a variety of digital image formats.

The American College of Radiology (ACR) and the National Electrical Manufacturers Association (NEMA) formed a joint committee in 1983 to develop a standard to:

- Promote communication of digital image information, regardless of device manufacturer
- Facilitate the development and expansion of picture archiving and communication systems (PACS) that can also interface with other systems of hospital information

- Allow the creation of diagnostic information data bases that can be interrogated by a wide variety of devices distributed geographically.

ACR-NEMA Standards Publication No. 300-1985, published in 1985 was designated version 1.0. The Standard was followed by two revisions: No. 1, dated October 1986 and No. 2, dated January 1988. These Standards Publications specified a hardware interface, a minimum set of software commands, and a consistent set of data formats.

ACR-NEMA Standards Publication No. 300-1988, published in 1988 was designated version 2.0. It included version 1.0, the published revisions, and additional revisions. It also included new material to provide command support for display devices, to introduce a new hierarchy scheme to identify an image, and to add data elements for increased specificity when describing an image.

In 1993, ACR-NEMA Standard 300 was substantially revised and replaced by this Standard, designated Digital Imaging and Communications in Medicine (DICOM). It embodies a number of major enhancements to previous versions of the ACR-NEMA Standard:

- It is applicable to a networked environment. The ACR-NEMA Standard was applicable in a point-to-point environment only; for operation in a networked environment a Network Interface Unit (NIU) was required. DICOM supports operation in a networked environment using the industry standard networking protocol TCP/IP.
- It is applicable to off-line media exchange. The ACR-NEMA Standard did not specify a file format or choice of physical media or logical filesystem. DICOM supports operation in an off-line media environment using industry standard media such as CD-R, DVD-R and USB and common file systems.
- It is a service oriented protocol, specifying the semantics of commands and associated data, and how devices claiming conformance to the Standard react to commands and data being exchanged. Specified services include support for management of the workflow of an imaging department. The ACR-NEMA Standard was confined to the transfer of data with only implicit service requirements.
- It specifies levels of conformance. The ACR-NEMA Standard specified a minimum level of conformance. DICOM explicitly describes how an implementor must structure a Conformance Statement to select specific options.

In 1995, with the addition of DICOM capabilities for cardiology imaging supported by the American College of Cardiology, the ACR-NEMA Joint Committee was reorganized as the DICOM Standards Committee, a broad collaboration of stakeholders across all medical imaging specialties.

## 1.4 Principles

### 1.4.1 Global Applicability and Localization

DICOM is a world-wide standard that can be used in every locale. It provides mechanisms to handle data that support cultural requirements, such as different writing systems, character sets, languages, and structures for addresses and person names. It supports the variety of workflows, processes and policies used for biomedical imaging in different geographic regions, medical specialties and local practices.

Localization to meet the requirements of national or local health and workflow policies can be done without deviating from the Standard. Such localization may include specifying code sets (e.g., procedure codes), or profiling data element usage (both specifying locally allowed values, and making elements that are optional in the Standard mandatory for local use).

Localization and profiling can be specified in a number of mechanisms outside the purview of the DICOM Standard. One such mechanism is Integration Profiles from the Integrating the Healthcare Enterprise (IHE) organization. It is important that Profiling adhere to the concept of non-contradiction. A Profile can add requirements but should not contradict DICOM requirements, as that would make it impossible to comply with both DICOM and the Profile.

### 1.4.2 Continuous Maintenance

The DICOM Standard is an evolving standard and it is maintained in accordance with the Procedures of the DICOM Standards Committee. Proposals for enhancements are welcome from all users of the Standard, and may be submitted to the Secretariat. Supplements and corrections to the Standard are balloted and approved several times a year. When approved as Final Text, each change becomes official, is published separately, and goes into effect immediately. At intervals, all of the approved Final Text changes are consolidated and published in an updated edition of the Standard. Once changes are consolidated into an updated edition of the Standard, the individual change documents are not maintained; readers are directed to use the consolidated edition of the Standard.

A requirement in updating the Standard is to maintain effective compatibility with previous editions.

The maintenance process may involve retirement of sections of the Standard.

Retirement does not imply that these features cannot be used. However, the DICOM Standards Committee will not maintain the documentation of retired features. The reader is referred to earlier editions of the Standard.

The use of the retired features is discouraged for new implementations, in favor of those alternatives remaining in the standard.

### **1.4.3 Information Objects and Unique Object Identification**

Many DICOM services involve the exchange of persistent information objects, such as images. An instance of such an information object may be exchanged across many systems and many organizational contexts, and over time. While minor changes may be made to the attributes of an instance to facilitate its handling within a particular organization (e.g., by coercing a Patient ID to the value used in a local context), the semantic content of an instance does not change.

Each instance is identified by a globally unique object identifier, which persists with the instance across all exchanges. Changes to the semantic content of an instance are defined to create a new instance, which is assigned a new globally unique object identifier.

### **1.4.4 Conformance**

Conformance to the DICOM Standard is stated in terms of Service-Object Pair (SOP) Classes, which represent Services (such as Storage using network, media, or web) operating on types of Information Objects (such as CT or MR images).

SOP Class specifications in the DICOM Standard are only changed in a manner that is intended to be forward and backward compatible for all editions of the Standard. Conformance requirements and conformance claims are therefore referenced to the identifier of the SOP Class, and never referenced to an edition of the Standard.

Each implementation is required to provide a Conformance Statement, in accordance with a consistent pro forma structure, facilitating comparison of products for interoperability.

### **1.4.5 Consistency of Information Model**

A large number of information objects defined in the DICOM Standard follow a common composite information model with information entities representing Patient, Study, Series, Equipment, Frame of Reference, and the specific instance data type. This information model is a simplification of the real world concepts and activities of medical imaging; for acquisition modalities, a Study is approximately equivalent to an ordered procedure, and a Series is approximately equivalent to a performed data acquisition protocol element. In other domains, such as Radiotherapy, the Study and Series are less clearly related to real world entities or activities, but are still required for consistency. This simplified model is sufficient for the pragmatic needs of managing imaging and related data collected in routine practice.

New information objects defined in DICOM will typically conform to this existing common information model, allowing reuse of implementations with minimal changes to support the new objects.



---

## 2 Normative References

[ISO/IEC Directives, Part 2] ISO/IEC. 2016/05. 7.0. *Rules for the structure and drafting of International Standards*. [http://www.iec.ch/members\\_experts/refdocs/iec/isoiecdir-2%7Bed7.0%7Den.pdf](http://www.iec.ch/members_experts/refdocs/iec/isoiecdir-2%7Bed7.0%7Den.pdf) .

[ACR/NEMA 300] ACR/NEMA. 1988. *Digital Imaging and Communications*.

[ISO/IEC 8822] ISO/IEC. 1994. *Information Processing Systems - Open Systems Interconnection - Connection Oriented Presentation Service Definition*.

[ISO/IEC 8649] ISO/IEC. 1996. *Information Processing Systems - Open Systems Interconnection - Service Definition for the Association Control Service Element*. *Withdrawn 2012*. .





## 3 Definitions

Attribute	A property of an Information Object. An Attribute has a name and a value that are independent of any encoding scheme.
Command	A request to operate on information across a network.
Command Element	An encoding of a parameter of a command that conveys this parameter's value.
Command Stream	The result of encoding a set of DICOM Command Elements using the DICOM encoding scheme.
Conformance Statement	A formal statement that describes a specific product implementation that uses the DICOM Standard. It specifies the Service Classes, Information Objects, and Communication Protocols supported by the implementation.
Data Dictionary	A registry of DICOM Data Elements that assigns a unique tag, a name, value characteristics, and semantics to each Data Element.
Data Element	A unit of information as defined by a single entry in the data dictionary.
Data Set	Exchanged information consisting of a structured set of Attributes. The value of each Attribute in a Data Set is expressed as a Data Element.
Data Stream	The result of encoding a Data Set using the DICOM encoding scheme (Data Element Numbers and representations as specified by the Data Dictionary).
Information Object	An abstraction of a real information entity (e.g., CT Image, Structured Report, etc.) that is acted upon by one or more DICOM Commands.  Note  This term is primarily used in PS3.1, with a few references in PS3.3. It is an informal term corresponding to a formal term that is introduced in PS3.3. In all other parts of the DICOM Standard this formal term is known as an Information Object Definition.
Information Object Class	A formal description of an Information Object, which includes a description of its purpose and the Attributes it possesses. It does not include values for these attributes.  Note  This term is only used in PS3.1. It is an informal term corresponding to a formal term that is introduced in PS3.4. This formal term is known as a Service-Object Pair Class or more commonly as a SOP Class.
Information Object Instance	A representation of an occurrence of an real-world entity, which includes values for the Attributes of the Information Object Class to which the entity belongs.  Note  This term is only used in PS3.1. It is an informal term corresponding to a formal term that is introduced in PS3.4. This formal term is known as a Service-Object Pair Instance or more commonly as a SOP Instance.
Message	A data unit of the Message Exchange Protocol exchanged between two cooperating DICOM Applications. A Message is composed of a Command Stream followed by an optional Data Stream.
Service Class	A structured description of a service that is supported by cooperating DICOM Applications using specific DICOM Commands acting on a specific class of Information Object.



## 4 Symbols and Abbreviations

<b>ACSE</b>	Association Control Service Element
<b>CT</b>	Computed Tomography
<b>DICOM</b>	Digital Imaging and Communications in Medicine
<b>HIS</b>	Hospital Information System
<b>JIRA</b>	Japan Medical Imaging and Radiological Systems Industries Association
<b>OSI</b>	Open Systems Interconnection
<b>PACS</b>	Picture Archiving and Communication Systems
<b>REST</b>	Representational State Transfer
<b>RESTful</b>	A RESTful Web service is a Web service implemented using REST architecture and HTTP (see <a href="http://www.ics.uci.edu/~fielding/pubs/dissertation/fielding_dissertation.pdf">http://www.ics.uci.edu/~fielding/pubs/dissertation/fielding_dissertation.pdf</a> )
<b>RIS</b>	Radiology Information System
<b>STOW-RS</b>	STore Over the Web by RESTful Services
<b>TCP/IP</b>	Transmission Control Protocol/Internet Protocol
<b>WADO-RS</b>	Web Access to DICOM Objects by RESTful Services
<b>WADO-URI</b>	Web Access to DICOM Objects by URI



# 5 The DICOM Communication Model

The DICOM Standard facilitates interoperability of devices claiming conformance. In particular, it:

- Addresses the semantics of Commands and associated data. For devices to interact, there must be standards on how devices are expected to react to Commands and associated data, not just the information that is to be moved between devices.
- Addresses the semantics of file services, file formats and information directories necessary for off-line communication.
- Is explicit in defining the conformance requirements of implementations of the Standard. In particular, a conformance statement must specify enough information to determine the functions for which interoperability can be expected with another device claiming conformance.
- Facilitates operation in a networked environment.
- Is structured to accommodate the introduction of new services, thus facilitating support for future medical imaging applications.
- Makes use of existing international standards wherever applicable, and itself conforms to established documentation guidelines for international standards.

Figure 5-1 presents the general communication model of the Standard, which spans both network (on-line) and media storage interchange (off-line) communication. Applications may utilize any of the following transport mechanisms:

- the DICOM Message Service and Upper Layer Service, which provides independence from specific physical networking communication support and protocols such as TCP/IP.
- the DICOM Web Service API and HTTP Service, which allows use of common hypertext and associated protocols for transport of DICOM services
- The Basic DICOM File Service, which provides access to Storage Media independently from specific media storage formats and file structures.

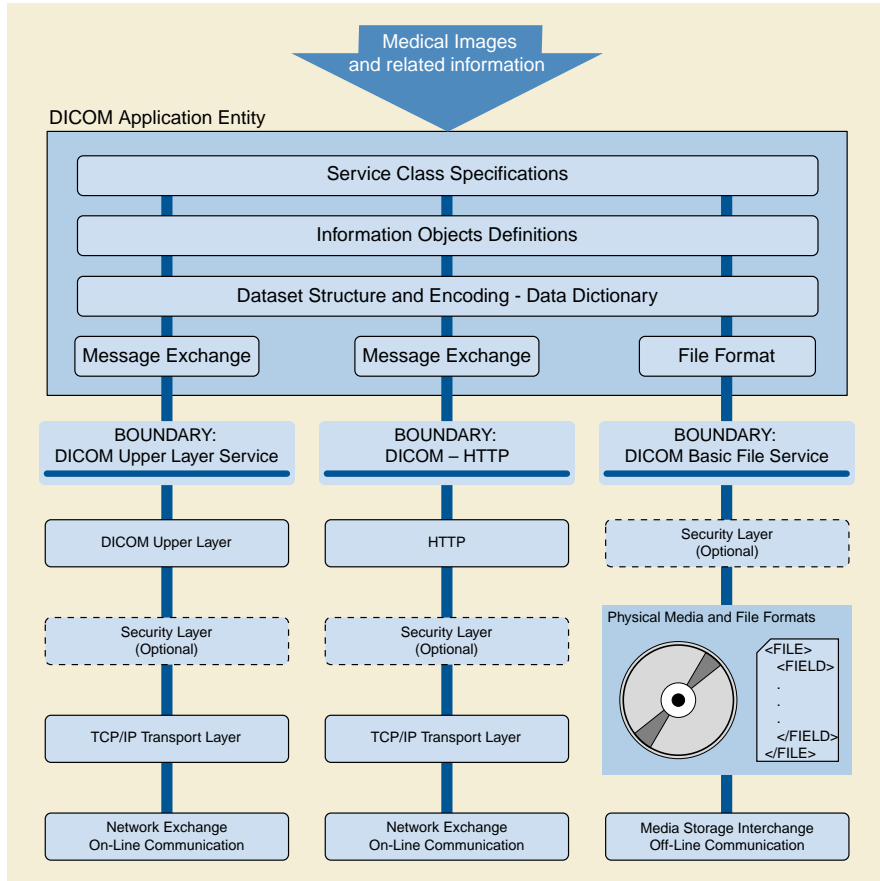

Figure 5-1. General Communication Model

# 6 Overview of The Content of The DICOM Standard

## 6.1 Document Structure

DICOM consists of the following parts:

- PS3.1: Introduction and Overview (this document)
- PS3.2: Conformance
- PS3.3: Information Object Definitions
- PS3.4: Service Class Specifications
- PS3.5: Data Structures and Encoding
- PS3.6: Data Dictionary
- PS3.7: Message Exchange
- PS3.8: Network Communication Support for Message Exchange
- PS3.9: Retired
- PS3.10: Media Storage and File Format for Media Interchange
- PS3.11: Media Storage Application Profiles
- PS3.12: Formats and Physical Media
- PS3.13: Retired
- PS3.14: Grayscale Standard Display Function
- PS3.15: Security and System Management Profiles
- PS3.16: Content Mapping Resource
- PS3.17: Explanatory Information
- PS3.18: Web Services
- PS3.19: Application Hosting
- PS3.20: Imaging Reports using HL7 Clinical Document Architecture
- PS3.21: Transformations between DICOM and other Representations

These parts of the Standard are related but independent documents. A brief description of each Part is provided in this section.

## 6.2 PS3.2: Conformance

PS3.2 of the DICOM Standard defines principles that implementations claiming conformance to the Standard shall follow:

- Conformance requirements. PS3.2 specifies the general requirements that must be met by any implementation claiming conformance. It references the conformance sections of other parts of the Standard.
- Conformance Statement. PS3.2 defines the structure of a Conformance Statement. It specifies the information that must be present in a Conformance Statement. It references the Conformance Statement sections of other parts of the Standard.

PS3.2 does not specify a testing/validation procedure to assess an implementation's conformance to the Standard.

Figure 6.2-1 and Figure 6.2-2 depict the construction process for a Conformance Statement for both network communication and media exchange. A Conformance Statement consists of the following parts:

- Set of Information Objects that is recognized by this implementation
- Set of Service Classes that this implementation supports
- Set of communications protocols or physical media that this implementation supports
- Set of security measures that this implementation supports.

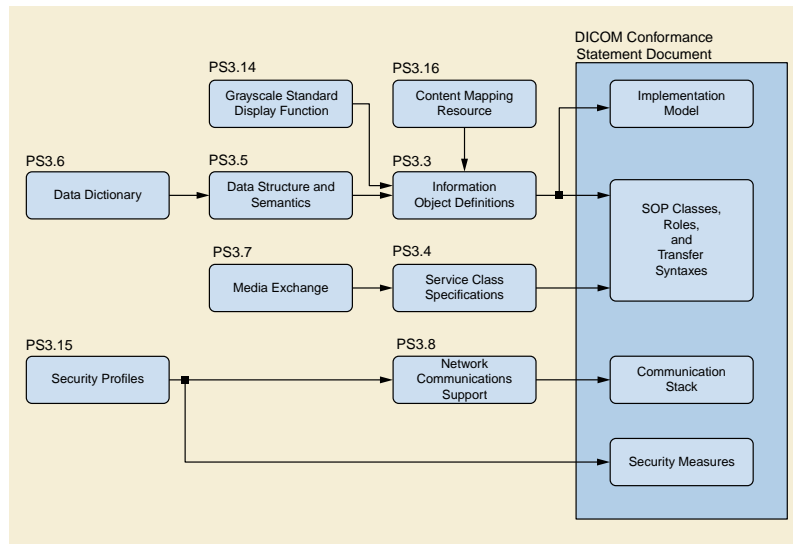

**Figure 6.2-1. Construction Process for a Network Conformance Claim**

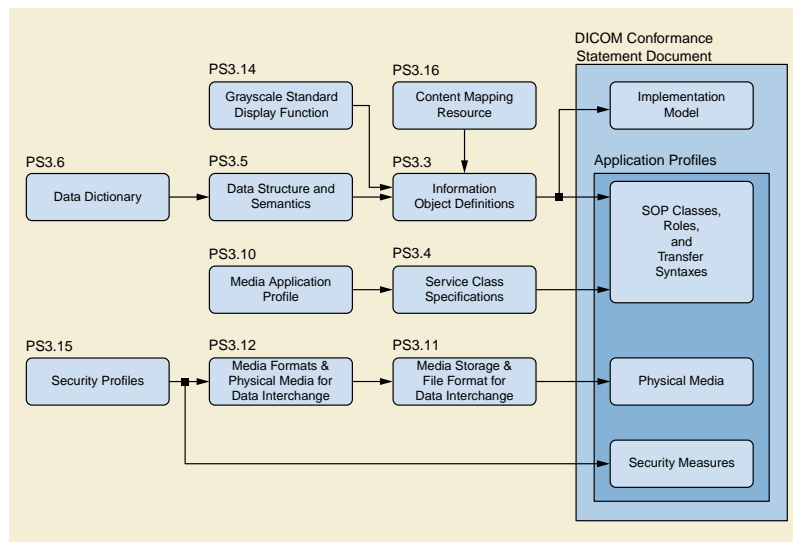

**Figure 6.2-2. Construction Process for a Media Conformance Claim**



## 6.3 PS3.3: Information Object Definitions

PS3.3 of the DICOM Standard specifies a number of Information Object Classes that provide an abstract definition of real-world entities applicable to communication of digital medical images and related information (e.g., waveforms, structured reports, radiation therapy dose, etc.). Each Information Object Class definition consists of a description of its purpose and the Attributes that define it. An Information Object Class does not include the values for the Attributes that comprise its definition.

Two types of Information Object Classes are defined: normalized and composite.

Normalized Information Object Classes include only those Attributes inherent in the real-world entity represented. For example the study Information Object Class, which is defined as normalized, contains study date and study time Attributes because they are inherent in an actual study. Patient name, however, is not an Attribute of the study Information Object Class because it is inherent in the patient on which the study was performed and not the study itself.

Composite Information Object Classes may additionally include Attributes that are related to but not inherent in the real-world entity. For example, the Computed Tomography Image Information Object Class, which is defined as composite, contains both Attributes that are inherent in the image (e.g., image date) and Attributes that are related to but not inherent in the image (e.g., patient name). Composite Information Object Classes provide a structured framework for expressing the communication requirements of images where image data and related data needs to be closely associated.

To simplify the Information Object Class definitions, the Attributes of each Information Object Class are partitioned with similar Attributes being grouped together. These groupings of Attributes are specified as independent modules and may be reused by other Composite Information Object Classes.

PS3.3 defines a model of the Real World along with the corresponding Information Model that is reflected in the Information Object Definitions. Future editions of this Standard may extend this set of Information Objects to support new functionality.

To represent an occurrence of a real-world entity, an Information Object Instance is created, which includes values for the Attributes of the Information Object Class. The Attribute values of this Information Object Instance may change over time to accurately reflect the changing state of the entity that it represents. This is accomplished by performing different basic operations upon the Information Object Instance to render a specific set of services defined as a Service Class. These Service Classes are defined in PS3.4 of the Standard.

## 6.4 PS3.4: Service Class Specifications

PS3.4 of the DICOM Standard defines a number of Service Classes. A Service Class associates one or more Information Objects with one or more Commands to be performed upon these objects. Service Class Specifications state requirements for Command Elements and how resulting Commands are applied to Information Objects. Service Class Specifications state requirements for both providers and users of communications services.

PS3.4 of the DICOM Standard defines the characteristics shared by all Service Classes, and how a Conformance Statement to an individual Service Class is structured. It contains a number of normative annexes that describe individual Service Classes in detail.

Examples of Service Classes include the following:

- Storage Service Class
- Query/Retrieve Service Class
- Basic Worklist Management Service Class
- Print Management Service Class.

PS3.4 defines the operations performed upon the Information Objects defined in PS3.3. PS3.7 defines the Commands and protocols for using the Commands to accomplish the operations and notifications described in PS3.4.

## 6.5 PS3.5: Data Structure and Semantics

PS3.5 of the DICOM Standard specifies how DICOM applications construct and encode the Data Set information resulting from the use of the Information Objects and Services Classes defined in PS3.3 and PS3.4 of the DICOM Standard. The support of a number of standard image compression techniques (e.g., JPEG lossless and lossy) is specified.

PS3.5 addresses the encoding rules necessary to construct a Data Stream to be conveyed in a Message as specified in PS3.7 of the DICOM Standard. This Data Stream is produced from the collection of Data Elements making up the Data Set.

PS3.5 also defines the semantics of a number of generic functions that are common to many Information Objects. PS3.5 defines the encoding rules for international character sets used within DICOM.

## 6.6 PS3.6: Data Dictionary

PS3.6 of the DICOM Standard is the centralized registry that defines the collection of all DICOM Data Elements available to represent information, along with elements utilized for interchangeable media encoding and a list of uniquely identified items that are assigned by DICOM.

For each element, PS3.6 specifies:

- its unique tag, which consists of a group and element number,
- its name,
- its value representation (character string, integer, etc),
- its value multiplicity (how many values per attribute),
- whether it is retired.

For each uniquely identified item, PS3.6 specifies:

- its unique value, which is numeric with multiple components separated by decimal points and limited to 64 characters,
- its name,
- its type, either Information Object Class, definition of encoding for data transfer, or certain well known Information Object Instances,
- in which part of the DICOM Standard it is defined.

## 6.7 PS3.7: Message Exchange

PS3.7 of the DICOM Standard specifies both the service and protocol used by an application in a medical imaging environment to exchange Messages over the communications support services defined in PS3.8. A Message is composed of a Command Stream defined in PS3.7 followed by an optional Data Stream as defined in PS3.5.

PS3.7 specifies:

- the operations and notifications (DIMSE Services) made available to Service Classes defined in PS3.4,
- rules to establish and terminate associations provided by the communications support specified in PS3.8, and the impact on outstanding transactions,
- rules that govern the exchange of Command requests and responses,
- encoding rules necessary to construct Command Streams and Messages.

## 6.8 PS3.8: Network Communication Support For Message Exchange

PS3.8 of the DICOM Standard specifies the communication services and the upper layer protocols necessary to support, in a networked environment, communication between DICOM applications as specified in PS3.3, PS3.4, PS3.5, PS3.6, and PS3.7. These communication services and protocols ensure that communication between DICOM applications is performed in an efficient and coordinated manner across the network.

The communication services specified in PS3.8 are a proper subset of the services offered by the OSI Presentation Service (ISO 8822) and of the OSI Association Control Service Element (ACSE) (ISO 8649). They are referred to as the Upper Layer Service, which allows peer applications to establish associations, transfer messages and terminate associations.

This definition of the Upper Layer Service specifies the use of the DICOM Upper Layer Protocol in conjunction with TCP/IP transport protocols.

The TCP/IP communication protocol specified by PS3.8 is a general purpose communication protocol not specific to the DICOM Standard. Figure 5-1 shows this protocol stack.

## **6.9 PS3.9: Retired (formerly Point-to-point Communication Support For Message Exchange)**

PS3.9 of the DICOM Standard previously specified the services and protocols used for point-to-point communications in a manner compatible with ACR-NEMA 2.0. It has been retired.

## **6.10 PS3.10 Media Storage and File Format**

PS3.10 of the DICOM Standard specifies a general model for the storage of medical imaging information on removable media (see Figure 6.10-1). The purpose of this Part is to provide a framework allowing the interchange of various types of medical images and related information on a broad range of physical storage media.

### Note

See Figure 5-1 for understanding how the media interchange model compares to the network model.

PS3.10 Specifies:

- a layered model for the storage of medical images and related information on storage media. This model introduces the concept of media storage application profiles, which specify application specific subsets of the DICOM Standard to which a media storage implementation may claim conformance. Such a conformance applies only to the writing, reading and updating of the content of storage media.
- a DICOM file format supporting the encapsulation of any Information Object;
- a secure DICOM file format supporting the encapsulation of a DICOM file format in a cryptographic envelope;
- a DICOM file service providing independence from the underlying media format and physical media.

PS3.10 defines various media storage concepts:

- the method to identify a set of files on a single medium
- the method for naming a DICOM file within a specific file system

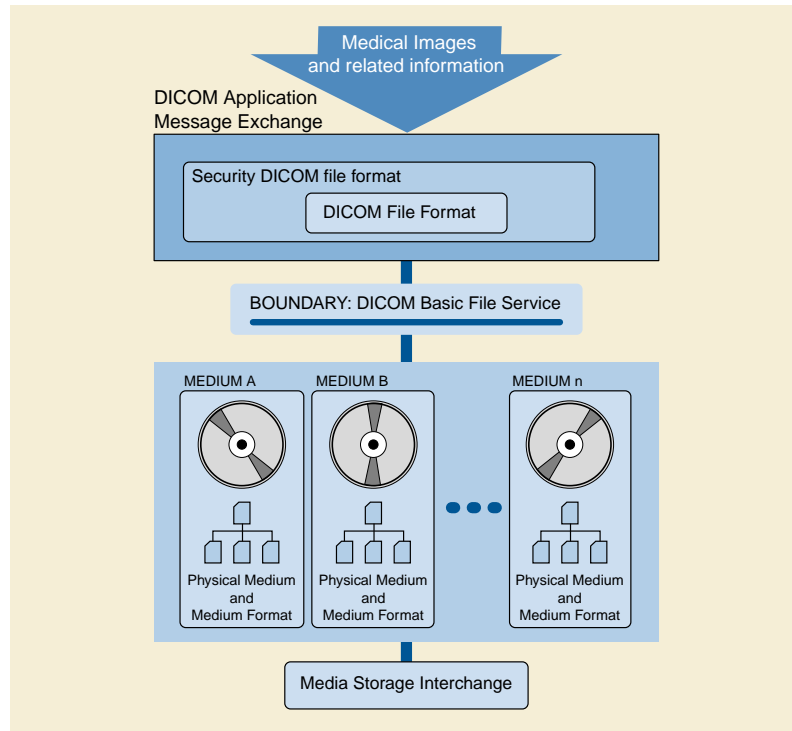

**Figure 6.10-1. DICOM Media Communication Model**

## 6.11 PS3.11: Media Storage Application Profiles

PS3.11 of the DICOM Standard specifies application specific subsets of the DICOM Standard to which an implementation may claim conformance. These application specific subsets will be referred to as Application Profiles in this section. Such a conformance statement applies to the interoperable interchange of medical images and related information on storage media for specific clinical uses. It follows the framework, defined in PS3.10, for the interchange of various types of information on storage media.

An Application Profile annex is organized into the following major parts:

- The name of the Application Profile, or the list of Application Profiles grouped in a related class
- A description of the clinical context of the Application Profile
- The definition of the media storage Service Class with the device roles for the Application Profile and associated options
- Informative section describing the operational requirements of the Application Profile
- Specification of the Information Object Classes and associated Information Objects supported and the encoding to be used for the data transfer
- The selection of media formats and physical media to be used
- Other parameters that need to be specified to ensure interoperable media interchange
- Security parameters that select the cryptographic techniques to be used with secure media storage Application Profiles

The structure of DICOM and the design of the Application Profile mechanism is such that extension to additional Information Object Classes and the new exchange media is straightforward.

### Note

Figure 6.11-1 shows how individual aspects of an Application profile map to the various parts of the DICOM Standard.

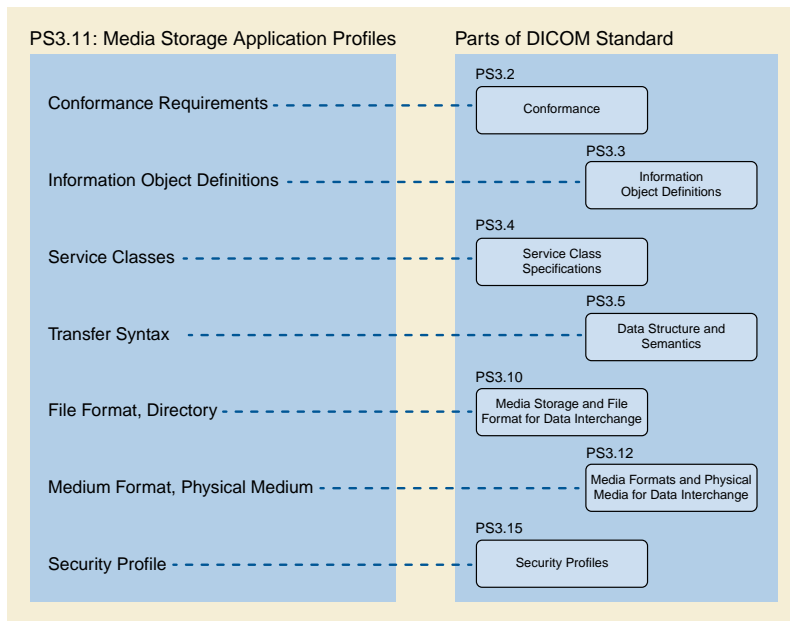

**Figure 6.11-1. Relationship Between an Application Profile and Parts of DICOM**

## 6.12 PS3.12: Storage Functions and Media Formats For Data Interchange

PS3.12 of the DICOM Standard facilitates the interchange of information between applications in medical environments by specifying:

- A structure for describing the relationship between the media storage model and a specific physical media and media format.
- Specific physical media characteristics and associated media formats.

## 6.13 PS3.13: Retired (formerly Print Management Point-to-point Communication Support)

PS3.13 previously specified the services and protocols used for point-to-point communication of print management services. It has been retired.

## 6.14 PS3.14: Grayscale Standard Display Function

PS3.14 specifies a standardized display function for consistent display of grayscale images. This function provides methods for calibrating a particular display system for the purpose of presenting images consistently on different display media (e.g., monitors and printers).

The chosen display function is based on human visual perception. Human eye contrast sensitivity is distinctly non-linear within the luminance range of display devices. This standard uses Barten's model of the human visual system.

## 6.15 PS3.15: Security and System Management Profiles

PS3.15 of the DICOM Standard specifies security and system management profiles to which implementations may claim conformance. Security and system management profiles are defined by referencing externally developed standard protocols, such as DHCP, LDAP, TLS and ISCL. Security protocols may use security techniques like public keys and "smart cards". Data encryption can use various standardized data encryption schemes.

This part does not address issues of security policies. The standard only provides mechanisms that can be used to implement security policies with regard to the interchange of DICOM objects. It is the local administrator's responsibility to establish appropriate security policies.

## 6.16 PS3.16: Content Mapping Resource

PS3.16 of the DICOM Standard specifies:

- templates for structuring documents as DICOM Information Objects
- sets of coded terms for use in Information Objects
- a lexicon of terms defined and maintained by DICOM
- country specific translations of coded terms

## 6.17 PS3.17: Explanatory Information

PS3.17 of the DICOM Standard specifies:

- informative and normative annexes containing explanatory information

## 6.18 PS3.18: Web Services

PS3.18 of the DICOM Standard specifies the means whereby Web Services can be used for retrieving or storing a DICOM object.

Requests that retrieve data specify the media type (format) of the response body. Requests that store data specify the media type of the request body.

The HTTP requests as defined within this standard are sufficient for the HTTP server to act as a DICOM SCU (Service Class User) to retrieve or store the requested objects from an appropriate DICOM SCP (Service Class Provider) using baseline DICOM functionality as defined in PS3.4 and PS3.7, which is to say that the HTTP server can act as a proxy for the DICOM SCP.

## 6.19 PS3.19: Application Hosting

PS3.19 of the DICOM Standard specifies an Application Programming Interface (API) to a DICOM based medical computing system into which programs written to that standardized interface can "plug-in" (see Figure 6.19-1). A Hosting System implementer only needs to create the standardized API once to support a wide variety of add-on Hosted Applications.

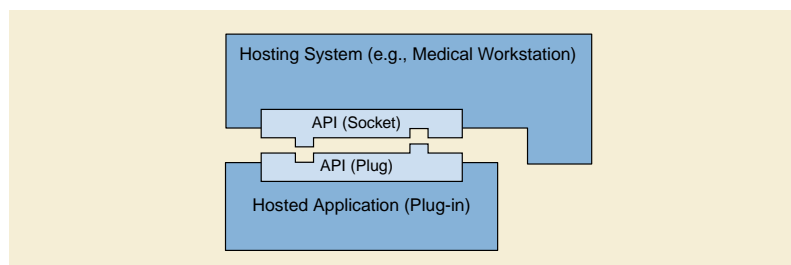

**Figure 6.19-1. Interface Between a Hosted Application and a Hosting System**

In the traditional "plug-in" model, the "plug-in" is dedicated to a particular host system (e.g., a web browsing program), and might not run under other host systems (e.g., other web browsing programs). PS3.19 defines an API that may be implemented by any Hosting System. A "plug-in" Hosted Application written to the API would be able run in any environment provided by a Hosting System that implements that API (see Figure 6.19-2).

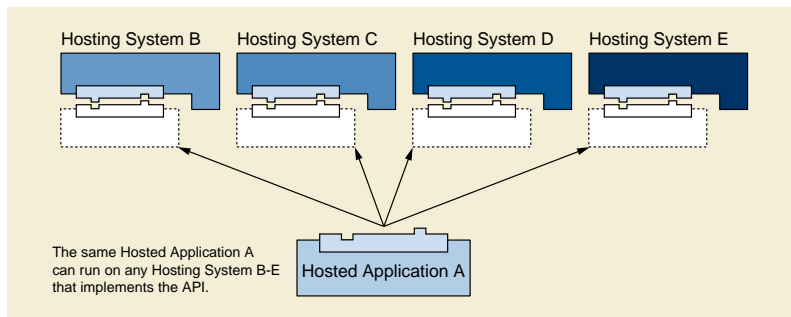

**Figure 6.19-2. Illustration of Platform Independence via the Hosted Application**

PS3.19 specifies both the interactions and the Application Programming Interfaces (API) between Hosting Systems and Hosted Applications. PS3.19 also defines the data models that are used by the API.

## 6.20 PS3.20: Imaging Reports using HL7 Clinical Document Architecture

PS3.20 of the DICOM Standard specifies templates for the encoding of imaging reports using the HL7 Clinical Document Architecture Release 2 (CDA R2, or simply CDA) Standard. Within this scope are clinical procedure reports for specialties that use imaging for screening, diagnostic, or therapeutic purposes.

PS3.20 constitutes an implementation guide for CDA, and is harmonized with the approach to standardized templates for CDA implementation guides developed by HL7. It also provides Business Names for data elements that link data in user terminology, e.g., collected by a report authoring application, to specific CDA encoded elements.

As an implementation guide for imaging reports, particular attention is given to the use and reference of data collected in imaging procedures as explicit evidence within reports. This data includes images, waveforms, measurements, annotations, and other analytic results managed as DICOM SOP Instances. Specifically, this Part includes a specification for transformation into CDA documents of DICOM Structured Report instances that represent imaging reports.

## 6.21 PS3.21: Transformations between DICOM and other Representations

PS3.21 of the DICOM Standard specifies the transformations between DICOM and other representations of the same information. Within its scope are transformations to and from the NCI Annotation and Image Markup format.





# 7 Referencing The DICOM Standard

Under the procedures of the DICOM Standards Committee, the Standard is in constant revision. Supplements and corrections to the Standard are balloted and approved several times a year. Each change when approved as Final Text immediately goes into effect. At intervals, all of the approved Final Text changes are consolidated into a published edition of the Standard, identified by year of publication, but such publication is only a convenience to the user; the Standard is officially changed when each change is approved.

Conformance to the DICOM Standard is through specified SOP Classes using DIMSE messages (see PS3.4), Web Services (see PS3.18), media interchange (see Annex I “Media Storage Service Class (Normative)” in PS3.4 and PS3.10), or the hosted application API (see PS3.19). Additional conformance claims may be made to Profiles (see PS3.11 and PS3.15). Once such a unit of conformance is specified in the Standard, all changes thereto are forward and backward compatible (except in rare cases where the original specification was non-interoperable, or conflicted with another standard). Conformance requirements and conformance claims are therefore referenced to the name and/or identifier of the feature, and never referenced to an edition of the Standard. Generally, the only appropriate reference to a particular edition of the Standard is to identify a retired feature (see Section 1.4.2 Continuous Maintenance).

The following citation form is preferred for general references to the Standard, without specification of date of edition, when specific conformance requirements are not invoked:

NEMA PS3 / ISO 12052, Digital Imaging and Communications in Medicine (DICOM) Standard, National Electrical Manufacturers Association, Rosslyn, VA, USA (available free at <http://medical.nema.org/>)

The requirements of this section do not override the requirement to provide a DICOM Conformance Statement as described in PS3.2.

The following forms are preferred for references to units of conformance to the Standard when they are made outside the context of a DICOM Conformance Statement (e.g., in customer requirements):

- “... conformant to the DICOM <name> SOP Class for network exchange [as a Service Class <User | Provider>], as specified in DICOM PS3.4: Service Class Specifications.”
- “... conformant to the DICOM <name> SOP Class for media exchange [as a File Set <Creator | Updater | Reader>], as specified in DICOM PS3.4: Service Class Specifications.”
- “... conformant to the DICOM <name> Web Service [as <an Origin-server | a User-agent>] [for the <name> SOP Class], as specified in DICOM PS3.18: Web Services.”
- “... conformant to DICOM Application Hosting [as a <Hosting System | Hosted Application>] for the <name> SOP Class, as specified in DICOM PS3.19: Application Hosting.”
- “... conformant to the DICOM <identifier> Application Profile [as a File Set <Creator | Updater | Reader>] [for the <name> SOP Class], as specified in DICOM PS3.11: Media Storage Application Profiles.”
- “... conformant to the DICOM <name> Profile, as specified in DICOM PS3.15: Security and System Management Profiles.”

## Note

1. Some Application Profiles and Web Services may fully specify the information objects exchanged, while others may require explicit specification of SOP Classes in the references.
2. Examples:
  - “The modality shall be conformant to the DICOM CT Image Storage and MR Image Storage SOP Classes for network exchange as a Service Class User, as specified in DICOM PS3.4: Service Class Specifications.”
  - “The workstation shall be conformant to the DICOM STD-XA1K-DVD Application Profile as a File Set Reader, as specified in DICOM PS3.11: Media Storage Application Profiles.”
  - “The PACS shall be conformant to the DICOM WADO-RS and STOW-RS Web Services as an Origin-server for the SOP Classes listed in Table X, as specified in DICOM PS3.18: Web Services.”

3. Such references are not permitted in lieu of a Conformance Statement for a product. For example, a product that reads or creates DICOM interchange media is required to have a Conformance Statement (as described in PS3.2) that enumerates the Media Application Profiles it implements. A statement in some other format, or a document that describes that a product supports recording of files of a particular SOP Class defined in PS3.4, is not sufficient as an alternative to a Conformance Statement.

Reference may be made to other features of the Standard, but these shall not be construed as DICOM conformance requirements (although they may be conformance requirements for non-DICOM implementation guides or regulations). Following are some examples:

- "... SOP Instances in accordance with the <name> Information Object Definition, as specified in DICOM PS3.3: Information Object Definitions."
- "... Structured Reporting SOP Instances using DICOM Template ID <number and name>, as specified in DICOM PS3.16: Content Mapping Resource."
- "... HL7 CDA instances using Template ID <identifier and name>, as specified in DICOM PS3.20: Imaging Reports using HL7 Clinical Document Architecture."
- "... using the <name> Transfer Syntax, as specified in DICOM PS3.5: Data Structure and Semantics."

#### Note

For example, products producing or receiving SR documents must conform to a SOP Class, such as Enhanced SR; such products may also cite use of Template ID 5200 Echocardiography Procedure Report, but that is not a formal DICOM Conformance assertion. However, a non-DICOM implementation guide, such as the IHE Echocardiography Workflow Profile, may require use of that Template, and an implementation may describe its use of specific Templates in its Conformance Statement.

Since changes to the Standard shall not be cited prior to adoption as Final Text, and since after adoption they are formally part of the Standard, there should be no citations to supplements or correction items for the purpose of describing conformance. Reference to such change documents may be made for describing the historical development of the DICOM Standard.