

2

4

6

Digital Imaging and Communications in Medicine (DICOM)

8

Supplement 191: Patient Radiation Dose Structured Report (P-RDSR)

10

12

14

16

18

20

22

24

Prepared by: WG-28 Physics

26 1300 N. 17th Street, Suite 900

Rosslyn, Virginia 22209 USA

28 VERSION: Final Text – April 5, 2017

Developed Pursuant to Work Item 2012-11-C

30

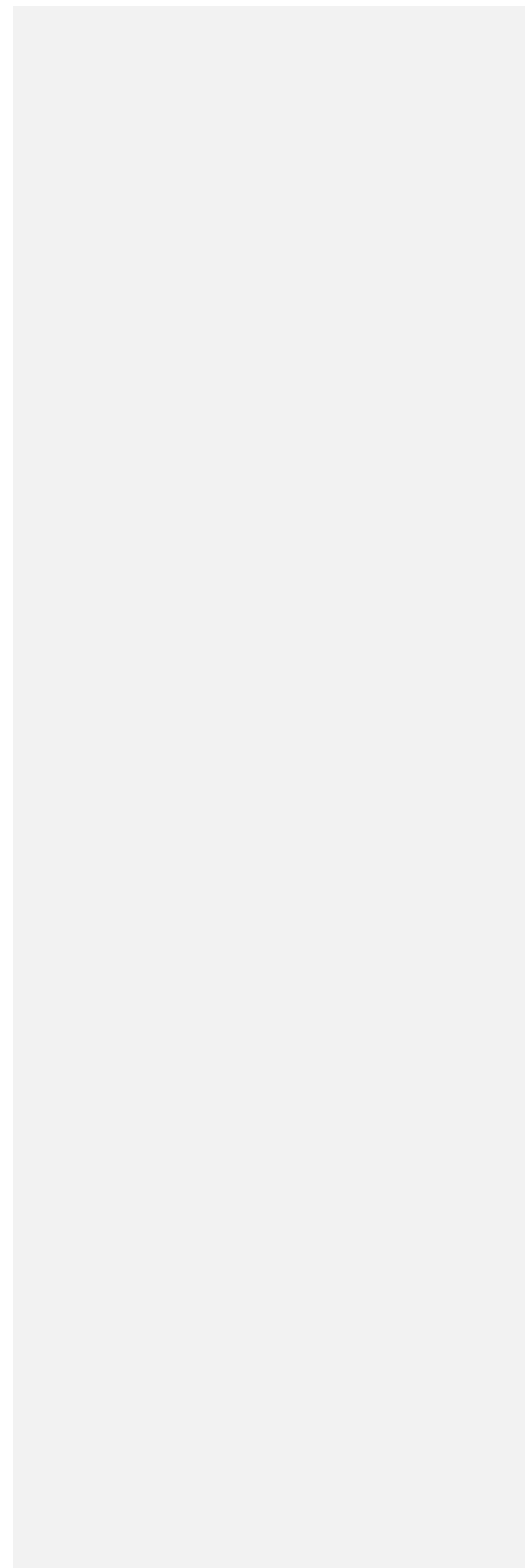

Table of Contents

32	Foreword.....	3
	Scope and Field of Application.....	3
34	Changes to NEMA Standards Publication PS 3.2-xxxx.....	5
	Changes to NEMA Standards Publication PS 3.3-xxxx.....	7
36	A.35.X Patient Radiation Dose SR IOD.....	8
	A.35.X.1 Patient Radiation Dose SR IOD Description.....	8
38	A.35.X.2 Patient Radiation Dose SR IOD Entity-Relationship Model.....	9
	A.35.X.3 Patient Radiation Dose SR IOD Module Table.....	9
40	A.35.X.3.1 Patient Radiation Dose SR IOD Content Constraints.....	9
	A.35.X.3.1.1 Template.....	9
42	A.35.X.3.1.2 Value Type.....	9
	A.35.X.3.1.3 Relationship Constraints.....	10
44	Changes to NEMA Standards Publication PS 3.4-xxxx.....	10
	B.5 STANDARD SOP CLASSES.....	11
46	B.5.1.5 Structured Reporting Storage SOP Classes.....	11
	I.4.1.2 Structured Reporting Storage SOP Classes.....	11
48	Changes to NEMA Standards Publication PS 3.6-xxxx.....	12
	Changes to NEMA Standards Publication PS 3.16-xxxx.....	14
50	PATIENT RADIATION DOSE STRUCTURED REPORT IOD TEMPLATES.....	15
	TID prdsrT01 Patient Radiation Dose.....	15
52	TID prdsrT02 Radiation Dose Estimate.....	16
	TID prdsrT03 Radiation Dose Estimate Representation.....	17
54	TID prdsrT04 Radiation Dose Estimate Methodology.....	18
	TID prdsrT05 Radiation Dose Estimate Parameters.....	22
56	CID prdsrCI12 Organs for Radiation Dose Estimates.....	23
	CID prdsrCI02 Absorbed Radiation Dose Types.....	23
58	CID prdsrCI02A Equivalent Radiation Dose Types.....	23
	CID prdsrCI13 Radiation Dose Estimate Distribution Representation.....	24
60	CID prdsrCI03 Patient Model Type.....	24
	CID prdsrCI04 Radiation Transport Model Type.....	24
62	CID prdsrCI07 Attenuator Category.....	25
	CID 10006B Radiation Attenuator Materials.....	25
64	CID prdsrCI10 Estimate Method Types.....	26
	CID prdsrCI06A Radiation Dose Estimation Parameter.....	26
66	CID prdsrCI13 Radiation Dose Types.....	27
	Changes to NEMA Standards Publication PS 3.17-xxxx.....	35
68		

70

Foreword

72 This supplement to the DICOM standard introduces a template for Patient – Radiation Dose Reporting in
DICOM. The concepts of Structured Reporting are used in this context.

74 This document is a Supplement to the DICOM Standard. It is an extension to the following parts of the
published DICOM Standard:

	PS 3.2	Conformance
76	PS 3.3	Information Object Definitions
	PS 3.4	Service Class Specifications
78	PS 3.6	Data Dictionary
	PS 3.16	Content Mapping Resource
80	PS 3.17	Explanatory Information

82 This work was undertaken in liaison with the America Association of Physicists in Medicine (AAPM) and
European Federation of Medical Physicists (EFOMP).

84

Scope and Field of Application

86 This Supplement is creating a structured report to contain the information concerning the recording of the
estimated radiation dose to a patient.

88 This includes radiation dose from CT, projection X-Ray, and radiopharmaceutical administration
(diagnostic and therapeutic). Occupational radiation exposures and dose from external beam therapy, ion
beam therapy, or brachytherapy is out of scope.

90 There are multiple methodologies and models that can be used to estimate patient dose and these
methods are rapidly changing. Yet, once an estimate of the radiation dose absorbed by a patient is
92 performed, the storing and transferring in a standard format is needed for the radiation source data,
method used, parameters used within the method and the resulting dose estimate.

94 The approach taken here for the Patient Radiation Dose Structured Report (P-RDSR) is to define a new
Structured Report (SR) object template and SOP Class. This SR object, independent of the images or the
96 MPPS, could be routed to an appropriate Radiation Dose Information Reporter System. A system that
claims conformance to such an SR object would then be expected, as part of the conformance claim, to
98 appropriately deal with such data items.

100 This SR dose object allows the data flow and data management of patient estimated radiation dose reports
to be disentangled from the data flow and data management of images.

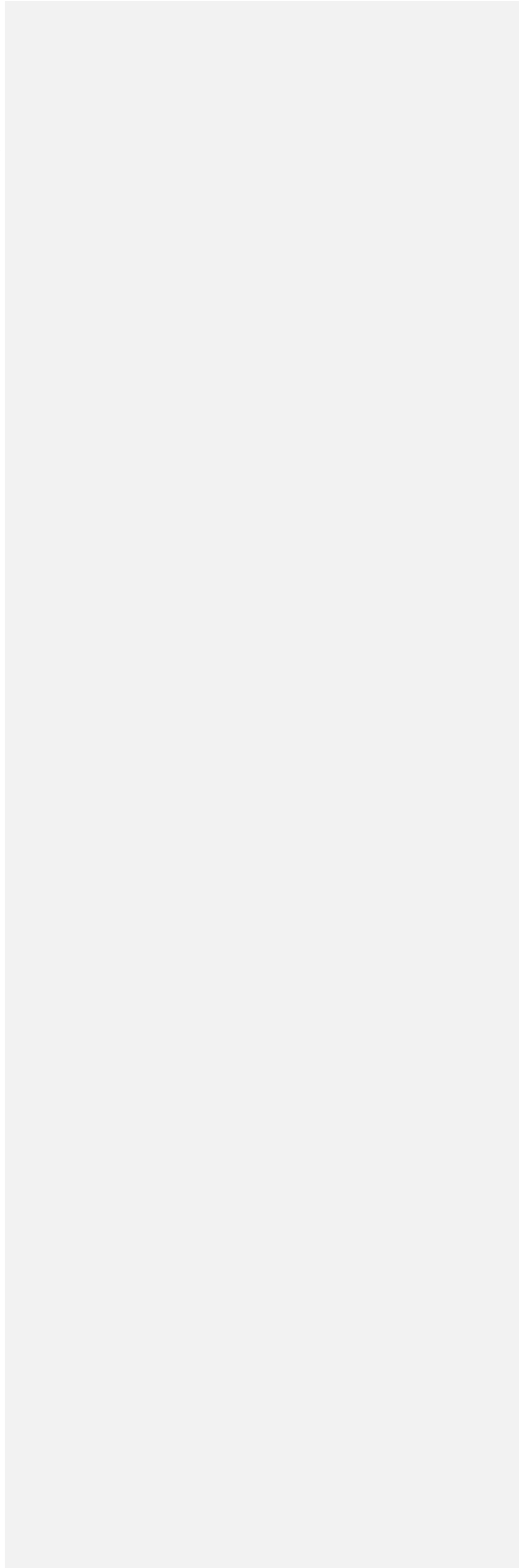

102

104

106

108

110

Changes to NEMA Standards Publication PS 3.2-xxxx

112

Digital Imaging and Communications in Medicine (DICOM)

Part 2: Conformance

114

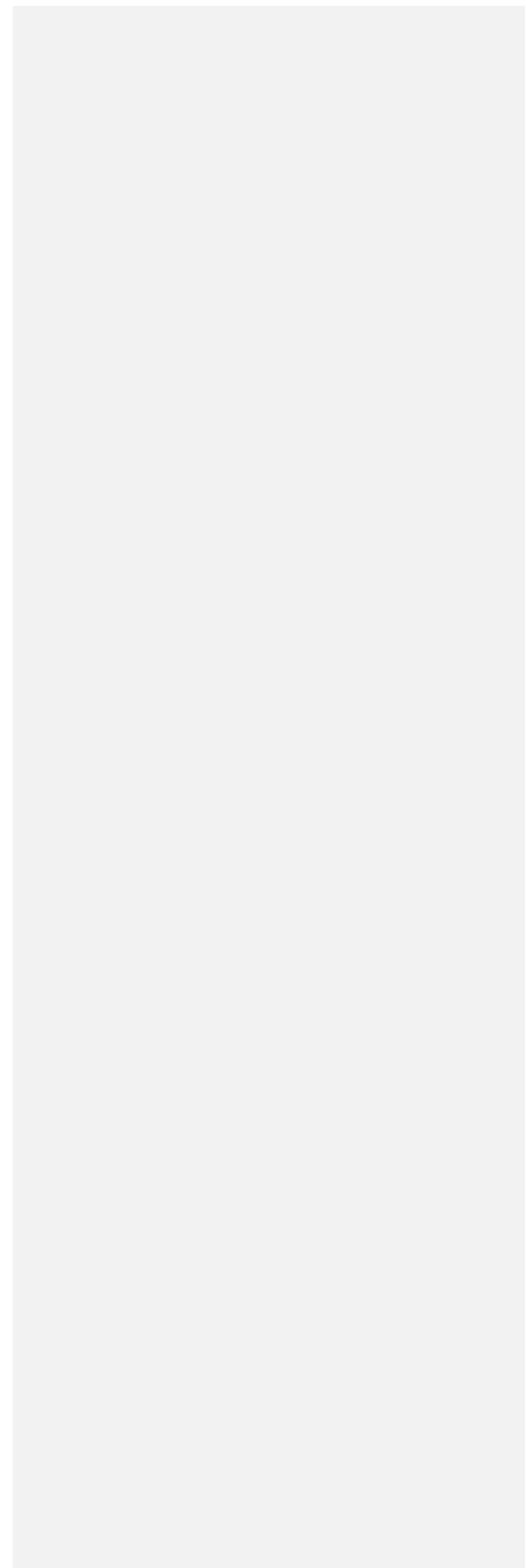

Item #01: Add new SOP Classes in Table A.1-2

116

Table A.1-2
UID VALUES

UID Value	UID NAME	Category
...		
<u>1.2.840.10008.5.1.4.1.1.88.x</u>	<u>Patient Radiation Dose SR</u>	<u>Transfer</u>
...		

118

120

122

124

126

Changes to NEMA Standards Publication PS 3.3-xxxx

128

**Digital Imaging and Communications in Medicine (DICOM)
Part 3: Information Object Definitions**

130

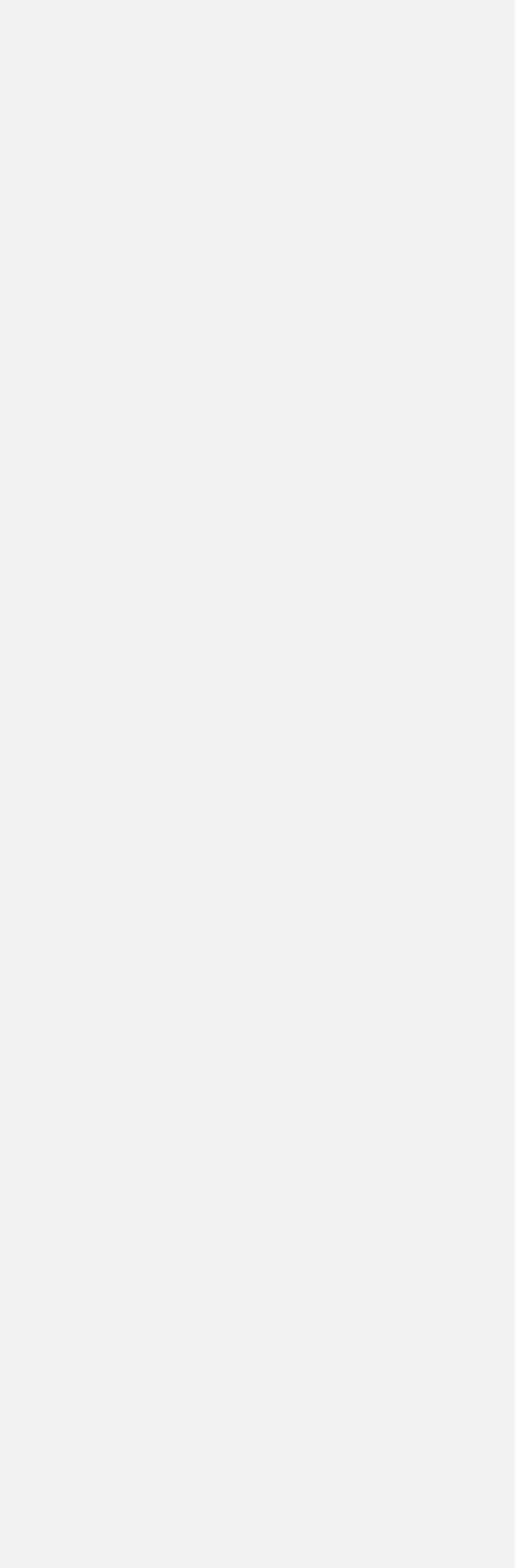

Add the following column in PS 3.3 Section A.1.4, Table A.1-3 Composite Information Object Modules Overview - More Non-Images

132

IODs Modules	<u>PRD</u> <u>SR</u>
Patient	<u>M</u>
Clinical Trial Subject	<u>U</u>
General Study	<u>M</u>
Patient Study	<u>U</u>
Clinical Trial Study	<u>U</u>
SR Document Series	<u>M</u>
Clinical Trial Series	<u>U</u>
Synchronization	<u>C</u>
General Equipment	<u>M</u>
Enhanced General Equipment	<u>M</u>
SR Document General	<u>M</u>
SR Document Content	<u>M</u>
SOP Common	<u>M</u>

Item #02: Add PS3.3 Section A.35.X:

134

A.35.X Patient Radiation Dose SR IOD

A.35.X.1 Patient Radiation Dose SR IOD Description

136 The Patient Radiation Dose Structured Report IOD is used to convey the information used in the
138 calculations for estimating the radiation dose to an individual patient. The complexity of the calculations
and the precision of the resulting dose estimate will vary depending on the need.

140 This IOD is not intended for determining patient dose from therapeutic use of radiation in oncology
settings. The therapeutic dose in oncology settings is reported by the RT Dose IOD.

142 **A.35.X.2 Patient Radiation Dose SR IOD Entity-Relationship Model**

The E-R Model in Section A.1.2 of this Part applies to the Patient Radiation Dose Structured Report IOD.

144 Table A.35.X-1 specifies the Modules of the Patient Radiation Dose SR IOD.

A.35.X.3 Patient Radiation Dose SR IOD Module Table

146

**Table A.35.X-1
Patient Radiation Dose Structured Report IOD MODULES**

IE	Module	Reference	Usage
Patient	Patient	C.7.1.1	M
	Clinical Trial Subject	C.7.1.3	U
Study	General Study	C.7.2.1	M
	Patient Study	C.7.2.2	U
	Clinical Trial Study	C.7.2.3	U
Series	SR Document Series	C.17.1	M
	Clinical Trial Series	C.7.3.2	U
Frame of Reference	Synchronization	C.7.4.2	C - shall be present if system time is synchronized to an external reference. May be present otherwise.
Equipment	General Equipment	C.7.5.1	M
	Enhanced General Equipment	C.7.5.2	M
Document	SR Document General	C.17.2	M
	SR Document Content	C.17.3	M
	SOP Common	C.12.1	M

148

A.35.X.3.1 Patient Radiation Dose SR IOD Content Constraints

150 **A.35.X.3.1.1 Template**

The document shall be constructed from Baseline TID prdsrT01 "Patient Radiation Dose Report" invoked at the root node.

152

A.35.X.3.1.2 Value Type

154 Value Type (0040,A040) in the Content Sequence (0040,A730) of the SR Document Content Module is constrained to the following Enumerated Values (see Table C.17.3-7 for Value Type definitions):

- 156 TEXT
- CODE
- 158 NUM
- DATETIME
- 160 UIDREF
- PNAME
- 162 COMPOSITE
- IMAGE
- 164 CONTAINER

166 **A.35.X.3.1.3 Relationship Constraints**

168 Relationships between content items in the content of this IOD shall be conveyed by-value. Table A.35.X-2 specifies the relationship constraints of this IOD. See Table C.17.3-2 for Relationship Type definitions.

170 **Table A.35.X-2**
RELATIONSHIP CONTENT CONSTRAINTS FOR Patient Radiation Dose Structured Report IOD

Source Value Type	Relationship Type (Enumerated Values)	Target Value Type
CONTAINER	CONTAINS	TEXT, CODE, NUM, DATETIME, UIDREF, PNAME, IMAGE, COMPOSITE, CONTAINER
CONTAINER	HAS OBS CONTEXT	DATETIME, CODE, TEXT, UIDREF, PNAME
TEXT, CODE, NUM, COMPOSITE	HAS OBS CONTEXT	TEXT, CODE, NUM, DATETIME, UIDREF, PNAME, COMPOSITE
CONTAINER, IMAGE, COMPOSITE	HAS ACQ CONTEXT	TEXT, CODE, NUM, DATETIME, UIDREF, PNAME, CONTAINER.
any type	HAS CONCEPT MOD	TEXT, CODE
TEXT, CODE, NUM, COMPOSITE	HAS PROPERTIES	TEXT, CODE, NUM, DATETIME, UIDREF, PNAME, IMAGE, COMPOSITE, CONTAINER.
PNAME	HAS PROPERTIES	TEXT, CODE, DATETIME, DATE, TIME, UIDREF, PNAME
TEXT, CODE, NUM	INFERRED FROM	TEXT, CODE, NUM, DATETIME, UIDREF, IMAGE, COMPOSITE, CONTAINER.

172

Note: The SOP Classes to which an IMAGE or COMPOSITE Value Type may refer, is documented in the Conformance Statement for an application (see PS 3.2 and PS 3.4).

174

176

Changes to NEMA Standards Publication PS 3.4-xxxx

178

Digital Imaging and Communications in Medicine (DICOM)

Part 4: Service Class Specifications

180

Item #05: Add SOP Class to Table B.3-3

182

**Table B.3-3
STANDARD AND RELATED GENERAL SOP CLASSES**

SOP Class Name	Related General SOP Class Name
...	
<u>Patient Radiation Dose SR Storage</u>	<u>Enhanced SR</u>
	<u>Comprehensive SR</u>
	<u>Comprehensive 3D SR</u>
	<u>Extensible SR</u>

184

Item #06: Add SOP Class to Table B.5-1

186

B.5 STANDARD SOP CLASSES

188

**Table B.5-1
STANDARD SOP CLASSES**

SOP Class Name	SOP Class UID	IOD (See PS 3.3)
...		
<u>Patient Radiation Dose SR Storage</u>	<u>1.2.840.10008.5.1.4.1.1.88.X</u>	<u>Patient Radiation Dose SR Storage IOD</u>

Item #07: Add Structured Reporting SOP Class to Section B.5.1.5

B.5.1.5 Structured Reporting Storage SOP Classes

The requirements of Annex O apply to the following SOP Classes:

- ...
- Patient Radiation Dose SR Storage

Item #09: Add SOP Class to Section I.4.1.2

I.4.1.2 Structured Reporting Storage SOP Classes

The requirements of Annex O apply to the following SOP Classes:

- ...
- Patient Radiation Dose SR Storage

200

202

204

206

Changes to NEMA Standards Publication PS 3.6-xxxx

208

**Digital Imaging and Communications in Medicine (DICOM)
Part 6: Data Dictionary**

210

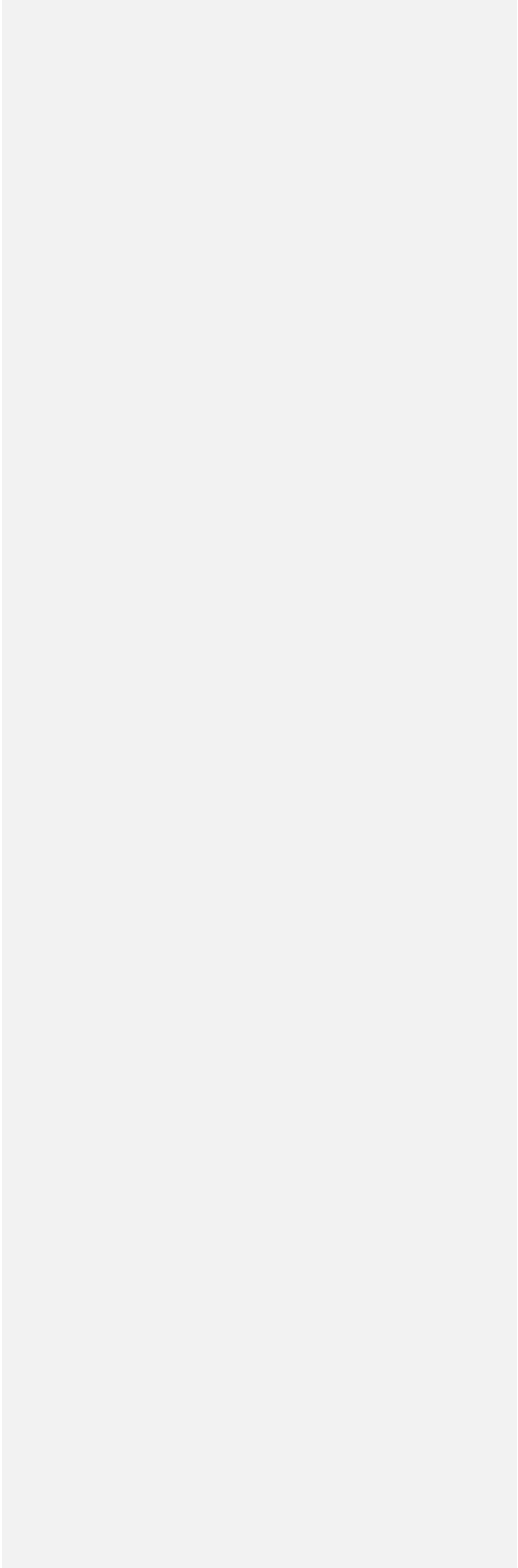

Item #10: Add the following row to Table A-1

UID Value	UID Name	UID Type	Part
...			
<u>1.2.840.10008.5.1.4.1.1.88.X</u>	<u>Patient Radiation Dose SR</u>	<u>SOP Class</u>	<u>PS 3.4</u>
...			

212

Item #11: Add the following row to Table A-1

Context UID	Context Identifier	Context Group Name
<u>1.2.840.10008.6.1.Z.1</u>	<u>CID prdsrCI12</u>	<u>Organs for Radiation Dose Estimates</u>
<u>1.2.840.10008.6.1.Z.2</u>	<u>CID prdsrCI02</u>	<u>Absorbed Radiation Dose Types</u>
<u>1.2.840.10008.6.1.Z.2A</u>	<u>CID prdsrCI02A</u>	<u>Equivalent Radiation Dose Types</u>
<u>1.2.840.10008.6.1.Z.3</u>	<u>CID prdsrCI13</u>	<u>Radiation Dose Estimate Distribution Representation</u>
<u>1.2.840.10008.6.1.Z.4</u>	<u>CID prdsrCI03</u>	<u>Patient Model Type</u>
<u>1.2.840.10008.6.1.Z.5</u>	<u>CID prdsrCI04</u>	<u>Radiation Transport Model Type</u>
<u>1.2.840.10008.6.1.Z.6</u>	<u>CID prdsrCI07</u>	<u>Attenuator Category</u>
<u>1.2.840.10008.6.1.Z.7</u>	<u>CID 10006B</u>	<u>Radiation Attenuator Materials</u>
<u>1.2.840.10008.6.1.Z.8</u>	<u>CID prdsrCI10</u>	<u>Estimate Method Types</u>
<u>1.2.840.10008.6.1.Z.9</u>	<u>CID prdsrCI06A</u>	<u>Radiation Dose Estimation Parameter</u>
<u>1.2.840.10008.6.1.Z.11</u>	<u>CID prdsrCI13</u>	<u>Radiation Dose Parameters</u>

Commented [NA1]: Add all CID

Commented [NA2]: Add all CID

Commented [NA3]: Add all CID

Commented [NA4]: Add all CID

Commented [NA5]: Add all CID

Commented [NA6]: Add all CID

Commented [NA7]: Add all CID

Commented [NA8]: Add all CID

Commented [NA9]: Add all CID

Commented [NA10]: Add all CID

214

216

218

220

222

224

Changes to NEMA Standards Publication PS 3.16-xxxx

Digital Imaging and Communications in Medicine (DICOM)

226

Part 16: Content Mapping Resource

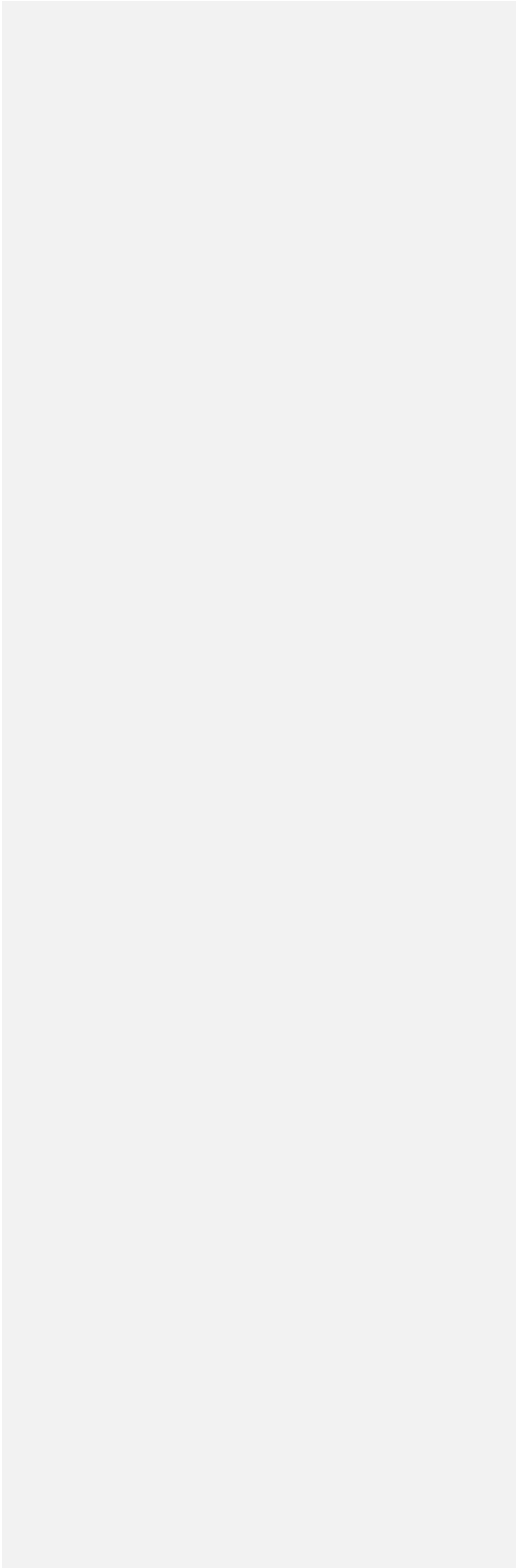

228 **Item #11: Add new Section to Annex A**

PATIENT RADIATION DOSE STRUCTURED REPORT IOD TEMPLATES

230 The templates that comprise the Patient Radiation Dose Structured Report are interconnected as in Figure A-x.

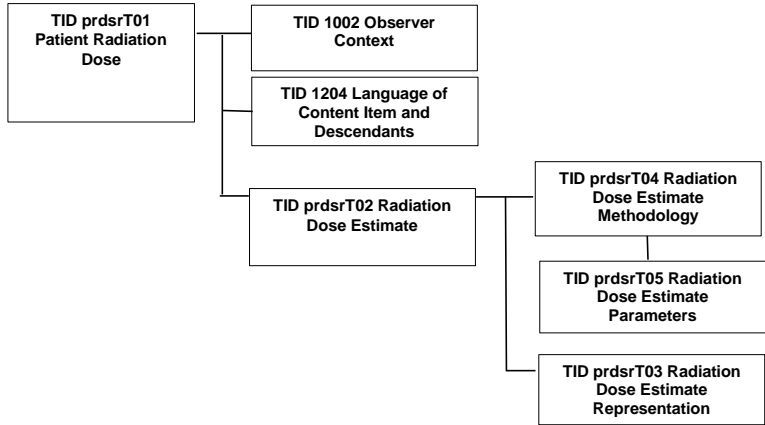

232

Figure A-x: Patient Radiation Dose Structured Report IOD Template Structure

234 **TID prdsrT01 Patient Radiation Dose**

236 This template defines a container (the root) with subsidiary content items for determining an estimated radiation dose to a patient.

238 **TID prdsrT01**
 240 **Patient Radiation Dose**
 242 **Type: Extensible**
Order: Non Significant
Root: Yes

	NL	Rel with Parent	VT	Concept Name	VM	Req Type	Condition	Value Set Constraint
1			CONTAINER	EV (prdsrCD001, DCM, "Patient Radiation Dose Report")	1	M		Root Node
2	>	HAS CONCEPT MOD	INCLUDE	DTID 1204 "Language of Content Item and Descendants"	1	M		
3	>	HAS OBS CONTEXT	INCLUDE	DTID (1002) "Observer Context"	1-n	M		
4	>	CONTAINS	INCLUDE	DTID (prdsrT02, "Radiation Dose Estimate")	1	M		

5	>	CONTAINS	TEXT	EV (121106, DCM, "Comment")	1	U		

244 **Content Item Descriptions**

Row 3	Identify all observers and devices involved with creating the organ estimations included in this Patient Radiation Dose SR.

246 **TID prdsrT02 Radiation Dose Estimate**

248 The dose estimate is used to record the results from one analysis method from one or more radiation sources. Organ dose estimates are calculated from one or more irradiation events to a patient. The output from one or more sources of radiation can be used separately or combined to estimate the dose to a patient or individual organs.

252 **TID prdsrT02
Radiation Dose Estimate
Type: Extensible
Order: Non Significant**

	NL	Rel with Parent	VT	Concept Name	VM	Req Type	Condition	Value Set Constraint
1		CONTAINS	CONTAINER	EV (prdsrCD002, DCM, "Radiation Dose Estimate")	1	M		
2	>	HAS CONCEPT MOD	TEXT	EV (prdsrCD003, DCM, "Radiation Dose Estimate Name")	1	M		
3	>	CONTAINS	TEXT	EV (121106, DCM, "Comment")	1	U		
4	>	CONTAINS	INCLUDE	DTID (prdsrT04, DCM, "Radiation Dose Estimate Methodology")	1	M		
5	>	CONTAINS	INCLUDE	DTID (prdsrT03, DCM, "Radiation Dose Estimate Representation")	1-n	U		
6	>	CONTAINS	CONTAINER	EV (113517, DCM, "Organ Radiation Dose Information")	1-n	M		
7	>>	CONTAINS	CODE	EV (T-D0060, SRT, "Organ")	1	M		DCID prdsrCI12 "Organs for Radiation Dose Estimates"
7A	>>>	HAS CONCEPT MOD	CODE	EV (G-C171, SRT, "Laterality")	1	MC	IF Row 7 has laterality	DCID 244 Laterality
8	>>	CONTAINS	TEXT	EV (121106, DCM, "Comment")	1	U		
9	>>	CONTAINS	NUM	DCID (prdsrCI02, "Absorbed Radiation Dose Types")	1	M		UNITS = EV (mGy, UCUM, "mGy")

11	>>>	HAS PROPERTI ES	NUM	DCID 225 "Measurement Uncertainty Concepts")	1-n	U		UNITS = EV (mGy, UCUM, "mGy")
12	>>>>	HAS PROPERTI ES	TEXT	EV (prdsrCD111, DCM, "Reference to Uncertainty Determination Method")	1	U		
13	>>	CONTAINS	NUM	DCID (prdsrCI02A, "Equivalent Radiation Dose Types")	1	U		UNITS = EV (mSv, UCUM, "mSv")
15	>>>	HAS PROPERTI ES	NUM	DCID 225 "Measurement Uncertainty Concepts")	1-n	U		UNITS = EV (mSv, UCUM, "mSv")
16	>>>>	HAS PROPERTI ES	TEXT	EV (prdsrCD111, DCM, "Reference to Uncertainty Determination Method")	1	U		

256 **Content Item Descriptions**

Row 13	Equivalent Dose is an international quantity and includes the use of a Radiation Weighting Factor to compensate for the radiation type, e.g., photon, neutron, alpha or beta particle, etc. Stating equivalent dose is not recommended in almost all dosimetry situations, except in Radiopharmaceutical dose. This is not Effective Dose.
--------	--

258

TID prdsrT03 Radiation Dose Estimate Representation

260 Different representations (e.g., images) of the distribution of absorbed energy allow a better understanding of how this energy may affect tissue.

262

**TID prdsrT03
Radiation Dose Estimate Representation
Type: Extensible
Order: Non Significant**

264

	NL	Rel with Parent	VT	Concept Name	VM	Req Type	Condition	Value Set Constraint
1			CONTAINER	EV (prdsrCD012, DCM, "Radiation Dose Estimate Representation")	1	M		
2	>	CONTAINS	CODE	EV (prdsrCD013, DCM, "Distribution Representation")	1	M		DCID prdsrCI13 "Radiation Dose Estimate Distribution Representation"
3	>	CONTAINS	IMAGE	EV (prdsrCD014, DCM, "Radiation Dose Representation Data")	1	MC	XOR Row 4	
4	>	CONTAINS	COMPOSITE	EV (prdsrCD014, DCM, "Radiation Dose Representation Data")	1	MC	XOR Row 3	

5	>	CONTAINS	CODE	EV (T-D0060,SRT, "Organ")	1-n	M		DCID prdsrCI12 "Organs for Radiation Dose Estimates"
5A	>>	HAS CONCEPT MOD	CODE	EV (G-C171, SRT, "Laterality")	1	MC	IF Row 5 has laterality	DCID 244 Laterality"
6	>	CONTAINS	TEXT	EV (121106, DCM, "Comment")	1	U		

266

Content Item Descriptions

Row 3 and 4	Reference to an Instance that contains the dose representation, e.g., surface segmentation, mesh, parametric map, RT dose SOP's, Secondary Capture, etc.
Row 5	The organs in the representation. The organs in this Row shall be present in Row 6 of TID prdsrT02 "Radiation Dose Estimate".

268

270 **TID prdsrT04 Radiation Dose Estimate Methodology**

This template includes the information specific to the organ dose calculation methodology used when estimating dose to individual organs, entire body or a phantom from imaging studies that use ionizing radiation.

272

274

**TID prdsrT04
Radiation Dose Estimate Methodology
Type: Extensible
Order: Non Significant**

	NL	Rel with Parent	VT	Concept Name	VM	Req Type	Condition	Value Set Constraint
1			CONTAINER	EV (prdsrCD015, DCM, "Radiation Dose Estimate Methodology")	1	M		
2	>	CONTAINS	COMPOSITE	EV (prdsrCD016, DCM, "SR Instance Used")	1-n	M		
3	>>	HAS OBS CONTEXT	COMPOSITE	EV (prdsrCD047, DCM, "Spatial Fiducials")	1-n	U		
4	>>	HAS PROPERTIES	UIDREF	EV (prdsrCD029, DCM, "Event UID Used")	1-n	MC	IFF some Events in the Structured Report were not used in calculating the dose.	
5	>	CONTAINS	CONTAINER	EV (prdsrCD100, DCM, "Patient Radiation Dose Model")	1	M		
6	>>	CONTAINS	CODE	EV (prdsrCD017, DCM, "Patient Model Type")	1	M		DCID prdsrCI03 "Patient Model Type"
7	>>	CONTAINS	CODE	EV (prdsrCD020, DCM, "Radiation Transport Model Type")	1	M		DCID prdsrCI04 "Radiation Transport Model Type"

Supplement 191: Patient Radiation Dose SR (PRDSR)
Page 19

8	>>	CONTAINS	IMAGE	EV (prdsrCD025, DCM, "Patient Radiation Dose Model Data")	1	UC	XOR Row 9, 10	
9	>>	CONTAINS	COMPOSITE	EV (prdsrCD025, DCM, "Patient Radiation Dose Model Data")	1	UC	XOR Row 8, 10	
10	>>	CONTAINS	UIDREF	EV (prdsrCD025, DCM, "Patient Radiation Dose Model Data")	1	UC	XOR Row 8, 9	
11	>>	CONTAINS	TEXT	EV (prdsrCD026, DCM, "Patient Radiation Dose Model Reference")	1	U		
12	>>	CONTAINS	TEXT	EV (121106, DCM, "Comment")	1	U		
13	>>	CONTAINS	CONTAINER	EV (prdsrCD027, DCM, "Patient Model Demographics")	1	M		
14	>>>	CONTAINS	NUM	EV (prdsrCD028, DCM, "Model Minimum Age")	1	MC	IF model requires minimum age to be defined	DCID 7456 "Units of Measure for Age"
15	>>>	CONTAINS	NUM	EV (prdsrCD030, DCM, "Model Maximum Age")	1	MC	IF model requires maximum age to be defined	DCID 7456 "Units of Measure for Age"
16	>>>	CONTAINS	CODE	EV (prdsrCD037, DCM, "Model Patient Sex")	1	MC	IF model requires sex to be defined.	DCID 7455 "Sex"
17	>>>	CONTAINS	NUM	EV (prdsrCD038, DCM, "Model Minimum Weight")	1	MC	IF model requires minimum weight to be defined	UNITS = EV (kg, UCUM, "kg")
18	>>>	CONTAINS	NUM	EV (prdsrCD041, DCM, "Model Maximum Weight")	1	MC	IF model requires maximum weight to be defined	UNITS = EV (kg, UCUM, "kg")
19	>>>	CONTAINS	NUM	EV (prdsrCD039, DCM, "Model Minimum Height")	1	MC	IF model requires minimum height to be defined	UNITS = EV (cm, UCUM, "cm")
20	>>>	CONTAINS	NUM	EV (prdsrCD042, DCM, "Model Maximum Height")	1	MC	IF model requires maximum height to be defined	UNITS = EV (cm, UCUM, "cm")
21	>>	CONTAINS	CONTAINER	EV (prdsrCD056, DCM, "Patient Model Registration")	1-n	UC	IF spatial information used from Radiation Dose SR or Patient Radiation Dose Model	
22	>>>	CONTAINS	TEXT	EV (121106, DCM, "Comment")	1	U		
23	>>>	CONTAINS	CODE	EV (prdsrCD046 DCM "Registration Method")	1	M		DCID 7100 "RCS Registration Method Type"
24	>>>	CONTAINS	COMPOSITE	EV (prdsrCD044, DCM, "Spatial Registration Reference")	1	MC	IFF Row 8, 9 or 10 are present and Frame of Reference is defined	

Supplement 191: Patient Radiation Dose SR (PRDSR)
Page 20

25	>	CONTAINS	CONTAINER	EV (prdsrCD057, DCM, "X-Ray Beam Attenuator")	1-n	MC	IF Attenuators used in estimation	
26	>>	CONTAINS	CODE	EV (prdsrCD058, DCM, "Attenuator Category")	1	M		DCID prdsrCI07 "Attenuator Category"
27	>>	CONTAINS	CODE	EV (prdsrCD065, DCM, "Equivalent Attenuator Material")	1	M		DCID 10006B "Radiation Attenuator Materials"
28	>>	CONTAINS	NUM	EV (prdsrCD069, DCM, "Equivalent Attenuator Thickness")	1	MC	IF the attenuator is of uniform thickness	UNITS = EV (mm, UCUM, "mm")
29	>>	CONTAINS	TEXT	EV (prdsrCD068, DCM, "Attenuator Description")	1	U		
30	>>	CONTAINS	CONTAINER	EV (prdsrCD072, DCM, "X-Ray Beam Attenuator Model")	1	U		
31	>>>	CONTAINS	CODE	EV (prdsrCD020, DCM, "Radiation Transport Model Type")	1	U		DCID prdsrCI04 "Radiation Transport Model Type"
32	>>>	CONTAINS	TEXT	EV (prdsrCD074, DCM, "X-Ray Beam Attenuator Model Reference")	1	U		
33	>>>	CONTAINS	IMAGE	EV (prdsrCD070, DCM, "X-Ray Attenuator Model Data")	1	UC	XOR Row 34, 35	
34	>>>	CONTAINS	COMPOSITE	EV (prdsrCD070, DCM, "X-Ray Attenuator Model Data")	1	UC	XOR Row 33, 35	
35	>>>	CONTAINS	UIDREF	EV (prdsrCD070, DCM, "X-Ray Attenuator Model Data")	1	UC	XOR Row 33, 34	
36	>>	CONTAINS	CONTAINER	EV (prdsrCD075, DCM, "X-Ray Beam Attenuator Model Registration")	1-n	U		
37	>>>	CONTAINS	CODE	EV (prdsrCD046, DCM, "Registration Method")	1	M		DCID 7100 "RCS Registration Method Type"
38	>>>	CONTAINS	TEXT	EV (121106, DCM, "Comment")	1	U		
39	>>>	CONTAINS	COMPOSITE	EV (prdsrCD044, DCM, "Spatial Registration Reference")	1	MC	IFF Row 33, 34 or 35 are present and Frame of Reference is defined	
40	>	CONTAINS	CONTAINER	EV (prdsrCD076, DCM, "Radiation Dose Estimate Method")	1-n	M		

41	>>	CONTAINS	CODE	EV (prdsrCD077, DCM, "Radiation Dose Estimate Method Type")	1	M		DCID prdsrC110 "Estimate Method Types"
42	>>	CONTAINS	INCLUDE	DTID prdsrT05 "Radiation Dose Estimate Parameters"	1	U		
43	>>	CONTAINS	TEXT	EV (prdsrCD082, DCM, "Radiation Dose Estimate Method Reference")	1	U		

278

Content Item Descriptions

Row 2	Reference to Radiation Dose SRs or Radiopharmaceutical Administration Dose SRs used in the dose estimation. At least one such SR shall be referenced. Note: If an SR does not exist, one must be created from estimated data.
Row 3	Reference to fiducial SOP Instance that is used to register the Frame of Reference of the Radiation Dose SR.
Row 4	Reference to Irradiation Event UIDs or Radiopharmaceutical Event UIDs used in the Radiation Dose Estimate Methodology. This shall not be present if all events in the SR are used.
Rows 8 and 9	Reference to an instance that contains the model used when determining the radiation transport and deposition of energy within a patient, e.g., Surface Segmentation, Mesh, Parametric Map, etc.
Row 10	Reference to the series of images that contains the model used when determining the radiation transport and deposition of energy within a patient,, e.g., CT, MRI, etc.
Row 11	Reference to Publication describing the model used. If proprietary, reference the manufacturer model and version of software used.
Rows 13 through 20	Provide the demographics used in the patient model to estimate dose. These are not necessarily the demographics of the actual patient.
Row 21	Contains the Spatial Registration from each Source Radiation Dose SR Frame of Reference to the patient model Frame of Reference. The Frame of Reference of patient model is defined by the space of model coordinates. The Frame of Reference of the Source Radiation Dose SR is the Frame of Reference of the acquired patient images. If no Frame of Reference of the acquired patient images exists, fiducials can be used to define Frame of Reference in both the equipment space, i.e., Source Radiation Dose SR, and the Patient Model space and referenced in Row 5. If RCS Registration Method Type is Visual Alignment, it is assumed any translation/rotation information from the visual alignment is added to other alignment translation/rotation information and saved as a single Spatial Registration SOP Instance.
Rows 25	One content item per attenuator. This can be information about materials in the radiation beam that is used in the estimation method and that may or may not have been included in the Radiation Dose SR. If the beam Attenuator (e.g., filter) is included here and is also in the Radiation Dose SR it is assumed additional information relative to the beam Attenuator material, shape, size, location was needed and this information was not in the Radiation Dose SR or the Radiation Dose SR information is considered incorrect or incomplete.
Row 27	The estimation method may use an equivalent material rather than the actual material, e.g., a plastic table may be use equivalent aluminum attenuation.
Row 28	If the attenuator is not uniform, a thickness may still be provided and it is expected that Row 29 (Attenuator Description) will clarify how that thickness was determined. The specified equivalent material is identified in Row 27.
Row 29	The attenuator characteristics may be described here. If the attenuator thickness was not provided in Row 28, the attenuator may still be described.
Row 30	Complex attenuators are best described by a model.
Rows 33 and 34	Reference to an instance that contains the model e.g., Surface Segmentation, Mesh, Parametric Map, etc.

Row 35	Reference to the series of images that contains the model, e.g., CT, MRI, etc. This can be spatial fiducials SOP Instance.
Row 36	Contains the Spatial Registration from each Source Radiation Dose SR Frame of Reference to the x-ray attenuator model Frame of Reference. The Frame of Reference of the x-ray attenuator model is defined by the space of model coordinates. The Frame of Reference of the Source Radiation Dose SR is the Frame of Reference of the acquired patient images. If no Frame of Reference of the acquired patient images exists, fiducials can be used to define Frame of Reference in both the equipment space, i.e., Source Radiation Dose SR, and x-ray attenuator model space and referenced in Row 30. If RCS Registration Method Type is Visual Alignment it is assumed any translation/rotation information from the visual alignment is added to other alignment translation/rotation information and saved as a single Spatial Registration SOP Instance.
Row 32 and 43	Provide name of method, reference to a publication or the manufacturer model and version

280

TID prdsrT05 Radiation Dose Estimate Parameters

282 This template includes the parameters that are specific to the Radiation Dose Estimate Method used in the algorithms when estimating dose to individual organs, phantoms, or the entire body from imaging studies
284 that use ionizing radiation.

286

**TID prdsrT05
Radiation Dose Estimate Parameters
Type: Extensible
Order: Non Significant**

288

NL	Rel with Parent	VT	Concept Name	VM	Req Type	Condition	Value Set Constraint
1		CONTAINER	EV (prdsrCD034, DCM, "Radiation Dose Estimate Parameters")	1	M		
2	>	CONTAIN S	DCID rdsrCI06A "Radiation Dose Estimation Parameter"	1-n	MC	IF Row 4 absent	UNITS = DCID 82 "Units of Measurement"
4	>	CONTAIN S	EV (prdsrCD036, DCM, "Radiation Dose Composite Parameters")	1-n	MC	IF Row 2 absent	
5	>>	CONTAIN S	EV (121106, DCM, "Comment")	1	U		

290

Content Item Descriptions

Row 2	These are the parameters of the method specified in Row 43 of TID prdsrT04 Radiation Dose Estimate Methodology . The code meanings should correlate directly with the names of the parameters used in the methodology documentation.
Row 4	References to Parametric Map Image, Mesh, encapsulated pdf, or other similar IOD.
Row 5	Describes the contents of the IOD referenced in Row 4

292

Item #12: Add the following CID's to Part 16 Annex B:

294 **CID prdsrCI12 Organs for Radiation Dose Estimates**

296 **Table CID prdsrCI12**
Organs for Radiation Dose Estimates
Type: Extensible Version: yyyyymmdd

Coding Scheme Designator	Code Value	Code Meaning
<i>Include CID 10044 "Radiosensitive Organs"</i>		
SRT	T-D0010	Entire Body
DCM	113681	Phantom

298

Item #12: Add the following CID's to Part 16 Annex B:

300 **CID prdsrCI02 Absorbed Radiation Dose Types**

302 **Table CID prdsrCI02**
Absorbed Radiation Dose Types
Type: Extensible Version: yyyyymmdd

Coding Scheme Designator	Code Value	Code Meaning
DCM	Prdsrxxx1	Maximum Absorbed Radiation Dose
DCM	Prdsrxxx2	Minimum Absorbed Radiation Dose
DCM	Prdsrxxx3	Mean Absorbed Radiation Dose
DCM	Prdsrxxx4	Mode Absorbed Radiation Dose
DCM	Prdsrxxx9	Median Absorbed Radiation Dose

304

CID prdsrCI02A Equivalent Radiation Dose Types

306 **Table CID prdsrCI02A**
Equivalent Radiation Dose Types
Type: Extensible Version: yyyyymmdd

Coding Scheme Designator	Code Value	Code Meaning
DCM	Prdsrxxx5	Maximum Equivalent Radiation Dose
DCM	Prdsrxxx6	Minimum Equivalent Radiation Dose
DCM	Prdsrxxx7	Mean Equivalent Radiation Dose
DCM	Prdsrxxx8	Mode Equivalent Radiation Dose
DCM	Prdsrxxx10	Median Equivalent Radiation Dose

310

CID prdsrCI13 Radiation Dose Estimate Distribution Representation

312

Table CID prdsrCI13
Radiation Dose Estimate Distribution Representation
Type: Extensible Version: yyyyymmdd

314

Coding Scheme Designator	Code Value	Code Meaning
DCM	prdsrCD084	Isodose
DCM	prdsrCD085	Skin Dose Map
DCM	prdsrCD087	3D Dose Map
DCM	prdsrCD088	Dose Gradient
DCM	prdsrCD096	Dose Point Cloud
DCM	121342	Dose Image

CID prdsrCI03 Patient Model Type

318

Table CID prdsrCI03
Patient Model Type
Type: Extensible Version: yyyyymmdd

Coding Scheme Designator	Code Value	Code Meaning
DCM	prdsrCD018	Simple Object Model
DCM	prdsrCD004	Anthropomorphic Model
DCM	prdsrCD094	Patient Segmented Model

320

CID prdsrCI04 Radiation Transport Model Type

322

Table CID prdsrCI04
Radiation Transport Model Type
Type: Extensible Version: yyyyymmdd

324

Coding Scheme Designator	Code Value	Code Meaning
DCM	prdsrCD021	Geometric Radiation Transport Model
DCM	prdsrCD022	Voxelized Radiation Transport Model
DCM	prdsrCD023	Mesh Radiation Transport Model
DCM	prdsrCD024	NURBS Radiation Transport Model
DCM	prdsrCD097	Measured Radiation Dose
DCM	prdsrCD006	BREP Radiation Transport Model

326 **Item #12: Add the following CID's to Part 16 Annex B:**

CID prdsrCI07 Attenuator Category

328
330

**Table CID prdsrCI07
Attenuator Category**

Type: Extensible Version: yyyyymmdd

Coding Scheme Designator	Code Value	Code Meaning
DCM	prdsrCD059	Table
DCM	prdsrCD060	Table Core
DCM	prdsrCD061	Table Outer Liner
DCM	prdsrCD062	Table Pad
SRT	A-2C152	X-ray shield
DCM	prdsrCD031	Beam Block
SRT	A-010FE	Shielding Block
DCM	prdsrCD092	Patient Support
DCM	113771	X-Ray Filters

332

Make extension to CID10006 X-Ray Filter Materials

Coding Scheme Designator	Code Value	Code Meaning	SNOMED-CT Concept ID	UMLS Concept Unique ID
....				
SRT	C-139F9	Tin or Tin compound		

334

CID 10006B Radiation Attenuator Materials

338

**Table CID 10006B
Radiation Attenuator Materials**

Type: Extensible Version: yyyyymmdd

Coding Scheme Designator	Code Value	Code Meaning
<i>Include Table CID 10006 X-Ray Filter Materials</i>		
SRT	F-61202	Carbon fiber

340

CID prdsrCI10 Estimate Method Types

342

**Table CID prdsrCI10
Estimate Method Types**

344

Type: Extensible Version: yyyyymmdd

Coding Scheme Designator	Code Value	Code Meaning
MSH	D009010	Monte Carlo Method
DCM	prdsrCD079	Tabular Data Algorithm
DCM	prdsrCD080	Analytical Algorithm
DCM	prdsrCD081	Empirical Algorithm

346 **CID prdsrCI06A**

Radiation Dose Estimation Parameter

348

**Table CID prdsrCI06A
Radiation Dose Estimation Parameter**

Type: Extensible Version: yyyyymmdd

Coding Scheme Designator	Code Value	Code Meaning
DCM	prdsrCD005	Breast Thickness
DCM	111634	Half Value Layer
DCM	111046	Percent Fibroglandular Tissue
DCM	prdsrCD007	DgN
DCM	prdsrCD008	Patient AP Dimension
DCM	prdsrCD009	Patient Lateral Dimension
DCM	prdsrCD010	SSDE Conversion Factor
DCM	prdsrCD011	Backscatter
DCM	113981	Water Equivalent Diameter Representative Value
DCM	113982	Water Equivalent Diameter Integrated Across Scan Range
DCM	113983	Water Equivalent Diameter From Raw Data
DCM	113984	Water Equivalent Diameter From Localizer
DCM	prdsrCD033	Tissue Air Ratio
DCM	prdsrCD052	Correction Factor
DCM	prdsrCD053	Curve Fit Parameter
DCM	prdsrCD055	Homogeneity Factor
DCM	prdsrCD122	Normalization Factor
DCM	prdsrCD123	Offset Factor
DCM	112031	Attenuation Coefficient
DCM	prdsrCD126	Tissue Fraction

DCM	prdsrCD127	Distance Correction
NCIt	C70774r	Unit Conversion Factor
DCM	121206	Distance

350

352 **CID prdsrCI13 Radiation Dose Types**

354

**Table CID prdsrCI13
Radiation Dose Types**

Type: Extensible Version: yyyyymmdd

Coding Scheme Designator	Code Value	Code Meaning
DCM	prdsrCD113	Absorbed Dose
DCM	prdsrCD112	Equivalent Dose

356

Make extension to CID7180 Abstract Multi-dimensional Image Model Component Semantics

Coding Scheme Designator	Code Value	Code Meaning	SNOMED-CT Concept ID	UMLS Concept Unique ID
....				
<u>Include CID prdsrCI13 "Radiation Dose Types"</u>				

358

360 **Item #: Add the following Coded terms to Part 16 Annex D: Table D-1**

Table D-1. DICOM Controlled Terminology Definitions

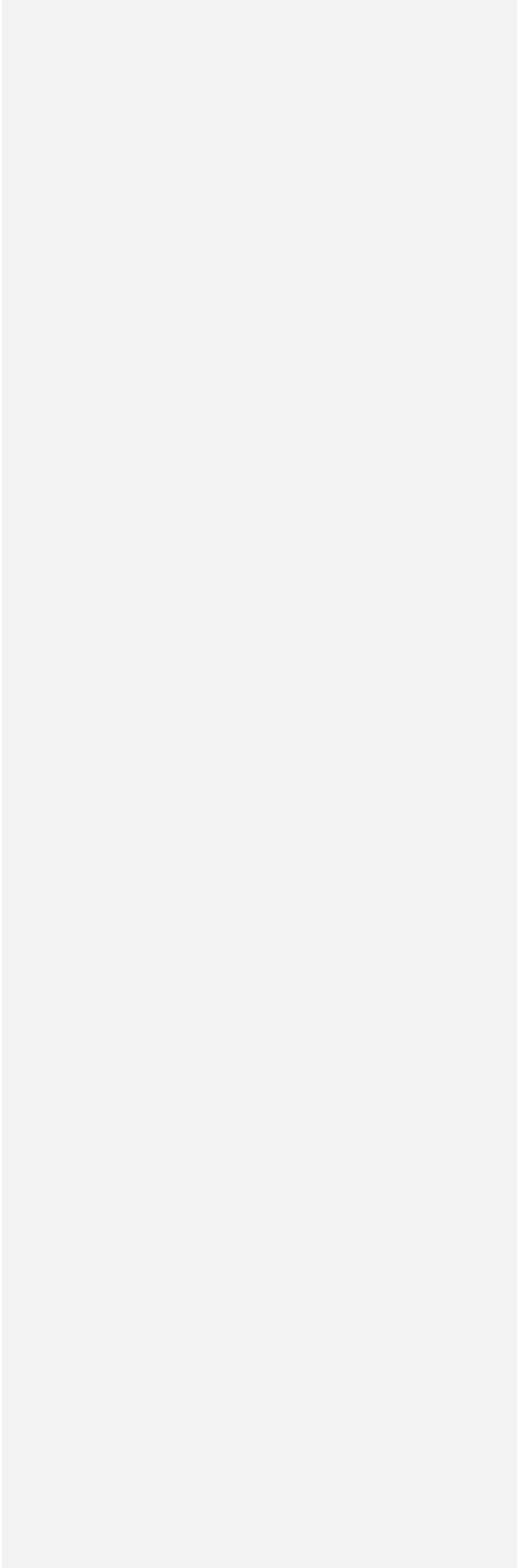

Supplement 191: Patient Radiation Dose SR (PRDSR)

Code Value	Code Meaning	Definition	Notes
prdsrCD001	Patient Radiation Dose Report	Report title for the report of estimated absorbed energy from ionizing radiation to a patient.	
prdsrCD002	Radiation Dose Estimate	Estimate of absorbed energy from ionizing radiation.	
prdsrCD003	Radiation Dose Estimate Name	Name used to identify a radiation dose estimate.	
prdsrCD004	Anthropomorphic Model	A mathematical description of a patient model for estimating radiation dose that describes or is thought of as having a human form or human attributes.	
prdsrCD005	Breast Thickness	Thickness of the breast.	
prdsrCD006	BREP Radiation Transport Model	Boundary based representation of the model for the estimation of radiation transport and absorbed dose in materials.	
prdsrCD007	DgN	Normalized Mean Glandular Dose (DgN) is the conversion value used to calculate the absorbed dose from radiation to the fibroglandular tissue component of the breast from the exposure in air.	
prdsrCD008	Patient AP Dimension	The size of a patient in the anterior-posterior dimension.	
prdsrCD009	Patient Lateral Dimension	The size of a patient in the lateral dimension.	
prdsrCD010	SSDE Conversion Factor	Conversion factor for Size Specific Dose Estimate (SSDE) calculations from $CTDI_{vol}$.	
prdsrCD011	Backscatter	Scattering of radiation in a direction opposite to that of the incident radiation.	
prdsrCD012	Radiation Dose Estimate Representation	The description of the representation of the estimated absorbed energy to an organ, a set of organs or the whole body, e.g., surface segmentation, mesh, parametric map, RT dose, Secondary Capture SOP Instances, etc.	
prdsrCD013	Distribution Representation	The form of the representation used to describe the distribution of the radiation dose.	
prdsrCD014	Radiation Dose Representation Data	The absorbed energy data estimated by the method.	
prdsrCD015	Radiation Dose Estimate Methodology	The methodology and parameters used to estimate the radiation dose to an organ, the whole body or a phantom.	
prdsrCD016	SR Instance Used	Reference to an SR instance used.	
prdsrCD017	Patient Model Type	The type of model used to define the shape, size, location of objects, etc. to represent a patient or phantom for use in radiation transport analysis.	

prdsrCD018	Simple Object Model	A simple object (e.g., cylinder) used to model a patient or organ.	
prdsrCD020	Radiation Transport Model Type	The type of model used to estimate energy transport and absorbed dose in materials.	
prdsrCD021	Geometric Radiation Transport Model	A model that uses geometrical shapes for the estimation of radiation transport and absorbed dose in materials.	
prdsrCD022	Voxelized Radiation Transport Model	A model that uses volumetric elements for the estimation of radiation transport and absorbed dose in materials.	
prdsrCD023	Mesh Radiation Transport Model	A model that uses a mesh structure representation for the estimation of radiation transport and absorbed dose in materials.	
prdsrCD024	NURBS Radiation Transport Model	A model that uses surfaces of a non-uniform rational B-spline (NURBS) based representation for the estimation of radiation transport and absorbed dose in materials.	
prdsrCD025	Patient Radiation Dose Model Data	The data from the model used to estimate radiation dose to a patient or organ.	
prdsrCD026	Patient Radiation Dose Model Reference	Rationale or reference to the methodology for the model used in the estimation of radiation dose.	
prdsrCD027	Patient Model Demographics	The demographics for which the patient model used by the radiation dose estimation method is intended.	
prdsrCD028	Model Minimum Age	The minimum age used in the patient model in the radiation dose estimation method.	
prdsrCD029	Event UID Used	Unique Identifier of an event used.	
prdsrCD030	Model Maximum Age	The maximum age used in the patient model in the radiation dose estimation method.	
prdsrCD031	Beam Block	A material placed in the radiation beam that is used to completely attenuate the beam in a specific region of the field of view.	
prdsrCD033	Tissue Air Ratio	Ratio of the absorbed dose at a given depth in tissue to the absorbed dose at the same point in air.	
prdsrCD034	Radiation Dose Estimate Parameters	The parameters used in the algorithms for determining the radiation dose to a patient, organs, or any material.	
prdsrCD036	Radiation Dose Composite Parameters	Reference to the SOP Instance that describes the parameters and values used in the algorithms for determining the radiation dose to a patient, organs, or any material.	
prdsrCD037	Model Patient Sex	The sex used in the patient model in the radiation dose estimation method.	

prdsrCD038	Model Minimum Weight	The minimum weight used in the patient model in the radiation dose estimation method.	
prdsrCD039	Model Minimum Height	The minimum height used in the patient model in the radiation dose estimation method.	
prdsrCD041	Model Maximum Weight	The maximum weight used in the patient model in the radiation dose estimation method.	
prdsrCD042	Model Maximum Height	The maximum height used in the patient model in the radiation dose estimation method.	
prdsrCD044	Spatial Registration Reference	Reference to the Spatial Registration instance or Deformable Spatial Registration instance.	
prdsrCD046	Registration Method	Name of the method used to register the frame of reference for two or more data sets.	
prdsrCD047	Spatial Fiducials	Reference to Spatial Fiducials SOP Instance.	
prdsrCD052	Correction Factor	A factor used to make an adjustment to a calculation to account for deviations.	
prdsrCD053	Curve Fit Parameter	A value used in a mathematical function to create a curve or a function that approximates a set of data.	
prdsrCD055	Homogeneity Factor	A value used to describe the uniformity or composition of a data set or a material that relates to the same degree of variability.	
prdsrCD056	Patient Model Registration	The spatial registration used in the patient model in the radiation dose estimation method.	
prdsrCD057	X-Ray Beam Attenuator	Attenuator in the radiation beam that may alter the estimated radiation dose to the patient, organs, or phantoms.	
prdsrCD058	Attenuator Category	The type of object in the radiation beam that may alter the estimated radiation dose to the patient, organs, or phantoms.	
prdsrCD059	Table	The table a patient is sitting, standing, or lying on and that is in the radiation beam such that it may alter the estimated radiation dose to the patient, organs, or phantoms.	
prdsrCD060	Table Core	The core material of a table a patient is sitting, standing, or lying on and that is in the radiation beam such that it may alter the estimated radiation dose to the patient, organs, or phantoms.	

prdsrCD061	Table Outer Liner	The outer shell of a table a patient is sitting, standing, or lying on and that is in the radiation beam such that it may alter the estimated radiation dose to the patient, organs, or phantoms.	
prdsrCD062	Table Pad	The padding on a table a patient is sitting, standing, or lying on and that is in the radiation beam such that it may alter the estimated radiation dose to the patient, organs, or phantoms.	
prdsrCD064	Radiation Dose Estimation Parameter Type	Parameters used in mathematical, simulation, or empirical calculations for radiation dose estimation.	
prdsrCD065	Equivalent Attenuator Material	The equivalent material used to estimate the reduction in radiation intensity.	
prdsrCD068	Attenuator Description	An explanation of the actual attenuator material used in the estimation of radiation dose.	
prdsrCD069	Equivalent Attenuator Thickness	The thickness of a specified material that provides the same attenuation as the actual attenuator.	
prdsrCD070	X-Ray Attenuator Model Data	The stored data from the model used to represent the X-Ray beam attenuator.	
prdsrCD072	X-Ray Beam Attenuator Model	Model of the attenuator used in the estimation of radiation dose.	
prdsrCD074	X-Ray Beam Attenuator Model Reference	Reference to the methodology or rationale for the model of the beam attenuator used in the estimation of radiation dose.	
prdsrCD075	X-Ray Beam Attenuator Model Registration	Spatial registration of the beam attenuator model.	
prdsrCD076	Radiation Dose Estimate Method	The container for the radiation dose estimation methods and parameters.	
prdsrCD077	Radiation Dose Estimate Method Type	Type of method used to estimate the radiation dose to a patient, organs or phantoms.	
prdsrCD079	Tabular Data Algorithm	Algorithms that use a table of values indexed by a key.	
prdsrCD080	Analytical Algorithm	Algorithms that use mathematical models that have a deterministic result.	
prdsrCD081	Empirical Algorithm	Algorithms that use mathematical models that use parameters derived from observation.	
prdsrCD082	Radiation Dose Estimate Method Reference	A reference to the methodology or rationale for the estimation methodology used for the estimation of radiation dose.	

prdsrCD084	Isodose	Representation of radiation dose of equal intensity as a surface, curve, or line.	
prdsrCD085	Skin Dose Map	Representation of radiation dose intensity at the surface on the skin.	
prdsrCD087	3D Dose Map	Representation of radiation dose as a 3D shape or object.	
prdsrCD088	Dose Gradient	Representation of the change in radiation dose with respect to the change in another variable. Often represented as a change with respect to time or distance.	
prdsrCD092	Physical Support	Material that is in radiation beam that is used to provide physical support to the patient or other objects.	
prdsrCD094	Patient Segmented Model	A model for estimating radiation dose defined from the actual patient anatomy or characteristics.	
prdsrCD096	Dose Point Cloud	Radiation dose represented as a distribution of points.	
prdsrCD097	Measured Radiation Dose	The measured amount of energy that is deposited in a material by ionizing radiation.	
prdsrCD100	Patient Radiation Dose Model	A computational representation of a human body or other object used to simulate the attenuation of radiation in human tissue.	
prdsrCD111	Reference to Uncertainty Determination Method	A reference to the methodology used to determine the uncertainty in the estimation of radiation dose.	
prdsrCD112	Equivalent Dose	Absorbed dose to a tissue or organ multiplied by a quality factor to normalize the dose to the type of radiation that is depositing the dose.	
prdsrCD113	Absorbed Dose	Energy from ionizing radiation absorbed per unit mass.	
prdsrCD122	Normalization Factor	A factor that is used to make an adjustment to a calculation to normalize the data set.	
prdsrCD123	Offset Factor	A factor that is used to make an adjustment to a calculation to translate or move the data set in a defined manner.	
prdsrCD126	Tissue Fraction	The amount of a specific tissue content, either mass or volume, in a material.	
prdsrCD127	Distance Correction	A correction factor for a measurement of distance or location.	
prdsrCD128	Conversion Factor	A numerical ratio to express a measurement from one unit to another unit.	

Prdsrxxx1	Maximum Absorbed Radiation Dose	The largest absorbed radiation dose amount estimated.	
Prdsrxxx2	Minimum Absorbed Radiation Dose	The smallest absorbed radiation dose value estimated.	
Prdsrxxx3	Mean Absorbed Radiation Dose	The average value of the absorbed radiation dose estimated.	
Prdsrxxx4	Mode Absorbed Radiation Dose	The absorbed radiation dose value estimated that occurs most frequently.	
Prdsrxxx9	Median Absorbed Radiation Dose	The central value of the absorbed radiation dose estimated.	
Prdsrxxx5	Maximum Equivalent Radiation Dose	The largest equivalent radiation dose value estimated.	
Prdsrxxx6	Minimum Equivalent Radiation Dose	The smallest equivalent radiation dose value estimated.	
Prdsrxxx7	Mean Equivalent Radiation Dose	The average value of the equivalent radiation dose estimated.	
Prdsrxxx8	Mode Equivalent Radiation Dose	The equivalent radiation dose value estimated that occurs most frequently.	
Prdsrxxx10	Median Equivalent Radiation Dose	The central value of the equivalent radiation dose estimated.	

364

366

368

370

Changes to NEMA Standards Publication PS 3.17-xxxx

372

**Digital Imaging and Communications in Medicine (DICOM)
Part 17: Explanatory Information**

374

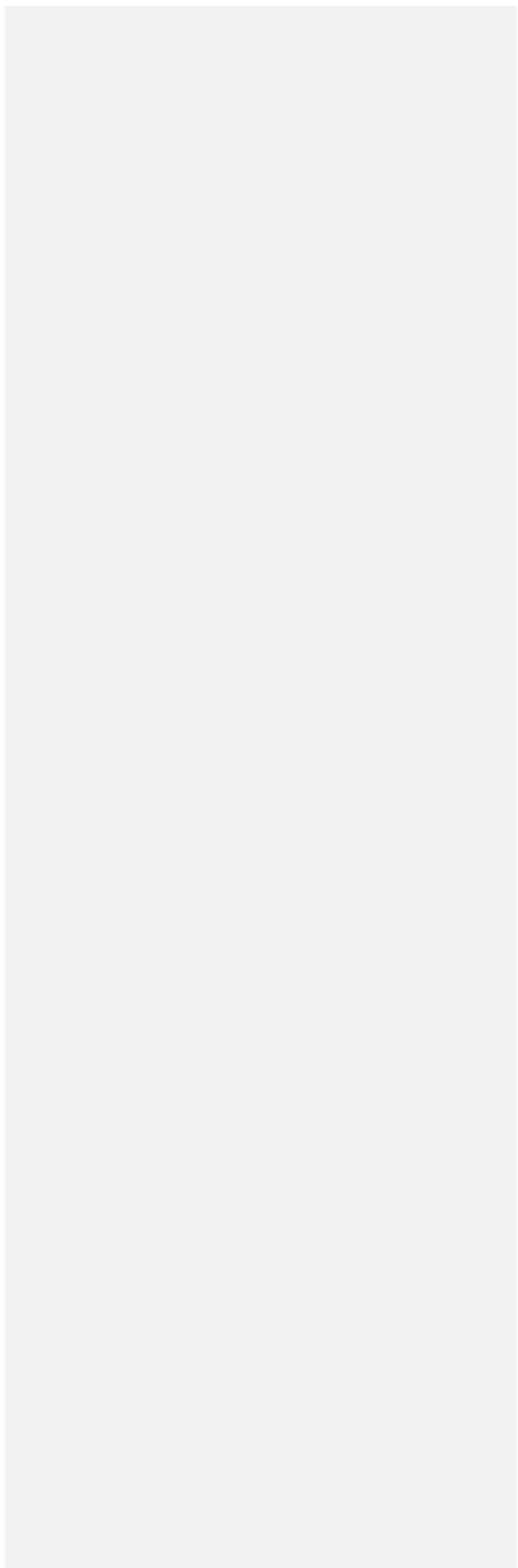

Item #15: Add Patient Radiation Dose Reporting Use Cases Annex

376 **XXX Patient Radiation Dose Structured
Report Document (Informative)**

378 This Annex contains examples of the use of Patient Radiation Dose templates within Patient Radiation Dose Structured Report Documents

380 **XXX.1 Skin Dose Map Example**

The following example shows the report of the skin dose map calculated from the dose delivered during an X-Ray interventional cardiology procedure.

384 The calculation uses a Radiation Dose SR provided by a Single Plane X-Ray Angiography equipment of the manufacturer "A". The Radiation Dose SR is created during one procedure step, corresponding to the coronary stenting of an adult male of 83 kg and 179 cm height.

386 The skin dose calculations are performed by an application on a separated workstation of the manufacturer "B", operated by the medical physicist, who is logged into the workstation at the time of the creation of the Patient Radiation Dose Structured Report document.

390 The dose calculation application generates a Patient Radiation Dose Structured Report document and a Secondary Capture Image containing an image of the dose distribution over the deployed skin of the patient model.

The dose calculation application uses the following settings and assumptions:

392 RDSR Source Data:

- All the Irradiation Event UIDs are used in the calculation of the skin dose map.

394

Patient Model:

- The patient model is a combination of two elliptic cylinders to represent the chest and neck of the patient.
- The actual dimensions of the model are determined by the age, gender, height, and weight of the patient.
- In this example the exact height and weight of the patient are used to create the model. The resulting elliptic cylinder for the chest of the model is 31 cm in the AP dimension and 74 cm in the lateral dimension.
- The application creates internally a 3D voxelized model that is stored in a DICOM SOP Instance.

402 Patient Model Registration:

- The distance from the top of the patient's head to the head of the table (measured during the procedure) is known. The location of the patient head and table head are stored in a Spatial Fiducials SOP instance.
- The application uses fiducials to register the patient model with the data of the source Radiation Dose SR.
- A-priori knowledge of the distance from the table head to the system Isocenter at table zero position is calibrated offline.
- The table tilt, cradle, and rotation angles are ignored because the description of the acquisition geometry is incomplete in the Radiation Dose SR. Only table translations relative to the Isocenter are considered in the calculations.

412 Beam Attenuators:

- A-priori knowledge of the model of the table and mattress (i.e., shape, dimensions, and absorption material) is calibrated offline, and it is referenced internally by the application. The model contains the same coordinate

414

- 416 system as the one used in the equipment referenced in the Radiation Dose SR, so there is no need of
another registration SOP instance.
- 418 • The X-Ray filter information from the source Radiation Dose SR is used by the application. There is no other
a-priori knowledge of the X-Ray filtration.

420 **Table XXX.1-1. Skin Dose Map Example**

Node	Code Meaning of Concept Name	Code or Example Value	Comment
1	Patient Radiation Dose Report	<CONTAINER>	TID prdsrT01
1.1	Language of Content Item and Descendants	(En, IETF4646, "English")	TID 1204
1.2	Observer Type	(121007,DCM, "Device")	TID 1002
1.3	Device Observer UID	1.2.3.4.566.1.5	TID 1004
1.4	Device Observer Name	MedPhys-01	TID 1004
1.5	Device Observer Manufacturer	Manufacturer B	TID 1004
1.6	Device Observer Model Name	Dose Workstation v1	TID 1004
1.7	Observer Type	(121006, DCM, "Person")	TID 1002
1.8	Person Observer Name	Doe^John^^Dr^PhD	TID 1003
1.9	Person Observer's Role in the Organization	(C1708969, UMLS, "Medical Physicist")	TID 1003
1.10	Radiation Dose Estimate	<CONTAINER>	TID prdsrT02
1.10.1	Radiation Dose Estimate Name	Skin Dose Map	TID prdsrT02
1.10.2	Comment	Single Plane XA	TID prdsrT02
1.10.3	Radiation Dose Estimate Methodology	<CONTAINER>	TID prdsrT04
1.10.3.1	SR Instance Used		Radiation Dose SR #1
1.10.3.1.1	SOP Class UID	1.2.840.1008.5.1.4.1.1.88.67	
1.10.3.1.2	SOP Instance UID	1.2.3.4.566.77.1	
1.10.3.1.3	Spatial Fiducials		Spatial Fiducials
1.10.3.1.3.1	SOP Class UID	1.2.840. 1008.5.1.4.1.1.66.2	
1.10.3.1.3.2	SOP Instance UID	1.2.3.4.44.222.33.1	

Node	Code Meaning of Concept Name	Code or Example Value	Comment
1.10.3.2	Patient Radiation Dose Model	<CONTAINER>	TID prdsrT04
1.10.3.2.1	Patient Model Type	(prdsrCD018, DCM, "Simple Object Model")	TID prdsrT04
1.10.3.2.2	Radiation Transport Model Type	(prdsrCD022, DCM, "Voxelized Radiation Transport Model")	TID prdsrT04
1.10.3.2.3	Patient Radiation Dose Model Data		Parametric map
1.10.3.1.3.1	SOP Class UID	1.2.840.1008.5.1.4.1.1.30	
1.10.3.1.3.2	SOP Instance UID	1.2.3.43.44.55.1	
1.10.3.2.4	Patient Radiation Dose Model Reference	DOI:1.2.3.4	TID prdsrT04
1.10.3.2.5	Comment	Combined Elliptic Cylinders	TID prdsrT04
1.10.3.2.6	Patient Model Demographics	<CONTAINER>	TID prdsrT04
1.10.3.2.6.1	Model Minimum Age	18 (a, UCUM, "year")	TID prdsrT04
1.10.3.2.6.2	Model Maximum Age	90 (a, UCUM, "year")	TID prdsrT04
1.10.3.2.6.3	Model Patient Sex	(M, DCM, "Male")	TID prdsrT04
1.10.3.2.6.4	Model Minimum Weight	83 (kg, UCUM, "kilogram")	TID prdsrT04
1.10.3.2.6.5	Model Maximum Weight	83 (kg, UCUM, "kilogram")	TID prdsrT04
1.10.3.2.6.6	Model Minimum Height	179 (cm, UCUM, "Centimeter")	TID prdsrT04
1.10.3.2.6.7	Model Maximum Height	179 (cm, UCUM, "Centimeter")	TID prdsrT04
1.10.3.2.7	Patient Model Registration	<CONTAINER>	TID prdsrT04
1.10.3.2.7.1	Comment	Distance from the top of patient's head to the head of the table = 10 cm	TID prdsrT04
1.10.3.2.7.2	Registration Method	(125022, DCM, "Fiducial Alignment")	TID prdsrT04
1.10.3.2.7.3	Spatial Registration		Spatial Registration
1.10.3.1.3.1	SOP Class UID	1.2.840. 1008.5.1.4.1.1.66.1	
1.10.3.1.3.2	SOP Instance UID	1.2.3.4.44.3.2.11	
1.10.3.3	X-Ray Beam Attenuator	<CONTAINER>	TID prdsrT04

Node	Code Meaning of Concept Name	Code or Example Value	Comment
1.10.3.3.1	Attenuator Category	(prdsrCD059, DCM, "Table")	TID prdsrT04
1.10.3.3.2	Equivalent Attenuator Material	(F-61202, SRT, "Carbon fiber")	TID prdsrT04
1.10.3.3.3	Equivalent Attenuator Thickness	100 (mm, UCUM, "Millimeter")	TID prdsrT04
1.10.3.3.4	Attenuator Description	X-Ray Table with Mattress	TID prdsrT04
1.10.3.3.5	X-Ray Beam Attenuator Model	<CONTAINER>	TID prdsrT04
1.10.3.3.5.1	Radiation Transport Model Type	(prdsrCD021, DCM, "Geometric Radiation Transport Model")	TID prdsrT04
1.10.3.3.5.2	X-Ray Beam Attenuator Model Reference	DOI:1.4.2.3	TID prdsrT04
1.10.3.4	Radiation Dose Estimate Method	<CONTAINER>	TID prdsrT04
1.10.3.4.1	Radiation Dose Estimate Method Type	(prdsrCD080, DCM, "Analytical Algorithm")	TID prdsrT04
1.10.3.4.2	Radiation Dose Estimate Parameters	<CONTAINER>	TID prdsrT05
1.10.3.4.2.1	(prdsrCD033, DCM, "Tissue Air Ratio")	1.06 ({ratio}, UCUM, "ratio")	TID prdsrT05
1.10.3.4.2.1.1	Radiation Dose Estimate Parameter Type	(C70774, NCIt, "Unit Conversion Factor")	TID prdsrT05
1.10.3.4.2.2	(prdsrCD008, DCM, "Patient AP Dimension")	31 (cm, UCUM, "Centimeter")	TID prdsrT05
1.10.3.4.2.2.1	Radiation Dose Estimate Parameter Type	(121206, DCM, "Distance")	TID prdsrT05
1.10.3.4.2.3	(prdsrCD009, DCM, "Patient Lateral Dimension")	74 (cm, UCUM, "Centimeter")	TID prdsrT05
1.10.3.4.2.3.1	Radiation Dose Estimate Parameter Type	(121206, DCM, "Distance")	TID prdsrT05
1.10.3.4.2.4	(MyCode001, MyScheme001, "Linear attenuation coefficient of the table and mattress")	0.010536 (/cm, UCUM, "/Centimeter")	TID prdsrT05
1.10.3.4.3	Radiation Dose Estimate Method Reference	DOI:4.2.13.4	TID prdsrT04
1.10.4	Radiation Dose Estimate Representation	<CONTAINER>	TID prdsrT03
1.10.4.1	Distribution Representation	(prdsrCD085, DCM, "Skin Dose Map")	TID prdsrT03
1.10.4.2	Radiation Dose Representation Data		TID prdsrT03

Node	Code Meaning of Concept Name	Code or Example Value	Comment
1.10.4.2.1	SOP Class UID	1.2.840.10008.5.1.4.1.1.7	Secondary Capture
1.10.4.2.2	SOP Instance UID	1.2.3.1.2.3.3	
1.10.4.3	Organ	(T-00009, SRT, "Skin")	TID prdsrT03
1.10.4.4	Comment	2D map of the dose on the deployed skin	TID prdsrT03
1.10.5	Organ Radiation Dose Information	<CONTAINER>	TID prdsrT02
1.10.5.1	Organ	(T-00009, SRT, "Skin")	TID prdsrT02
1.10.5.2	Comment	Skin in the area of the chest and neck	TID prdsrT02
1.10.5.3	(DCM, Prdsrxxx1, "Maximum Absorbed Radiation Dose")	3000 (mGy, UCUM, "mGy")	TID prdsrT02
1.10.5.3.1	(R-00363, SRT, "+/-, range of measurement uncertainty")	750 (mGy, UCUM, "mGy")	TID prdsrT02
1.11	Comment	Skin Dose Map Report	TID prdsrT01

424 **XXX.2 Dual-source CT Organ Radiation Dose Example**

The following example shows the report of the organ dose calculated for a dual-source CT scan.

426 The calculation uses a Radiation Dose SR provided by a CT system that has dual x-ray tubes. The Radiation Dose SR is created during the acquisition of Neck DE_CAROTID CT scan of an adult male of 75 kg and 165 cm height.

428 The dose calculations are performed on the CT system. The dose calculation application generates a Patient Radiation Dose Structured Report document and a Dose Point Cloud containing an image of the dose distribution for the patient model.
430

The dose calculation application uses the following settings and assumptions:

432 RDSR Source Data:

- 434 • The Irradiation Events associated with the CT Localizer Radiograph are excluded.
- The Irradiation Event UID from the helical CT series is used in the calculation of the organ dose.

436 Patient Model:

- 438 • The patient model is a stylized anthropomorphic model of the patient.
- Organs are represented by simple geometric shapes described by mathematical equations. The parameters of the equations describing the location, shape, and dimension of the organs are stored in a DICOM SOP Instance.
- 442 • In this example the gender and age of the patient are used to select the appropriate phantom from the existing phantom library.

444

Patient Model Registration:

- 446 • Image Content-based Alignment between the CT images Frame of Reference and the 3D stylized model Frame of Reference is used for registration.

448

Beam Attenuators:

- 450 • Additional Aluminum filtration is used in the methodology and the equivalent HVL for the scanner model used in the method is given.

452

Table XXX.2-1. Dual-source CT Organ Radiation Dose Example

Node	Code Meaning of Concept Name	Code or Example Value	Comment
1	Patient Radiation Dose Report	<CONTAINER>	TID prdsrT01
1.1	Language of Content Item and Descendants	(En, IETF4646, "English")	TID 1204
1.1.1	Country of Language	(CA, ISO3166_1, "Canada")	TID 1204
1.2	Observer Type	(121007, DCM, "Device")	TID 1002
1.3	Device Observer UID	2.13.4.5.2.33.5	TID 1004
1.4	Device Observer Name	RUMC-213	TID 1004
1.5	Device Observer Manufacturer	Manufacturer DEX	TID 1004

Node	Code Meaning of Concept Name	Code or Example Value	Comment
1.6	Device Observer Model Name	Scanner 4500	TID 1004
1.7	Radiation Dose Estimate	<CONTAINER>	TID prdsrT02
1.7.1	Radiation Dose Estimate Name	Dual-source Neck DE_CAROTID CT scan Tube A&B	TID prdsrT02
1.7.2	Comment	Tube A and B combined	TID prdsrT02
1.7.3	Radiation Dose Estimation Methodology	<CONTAINER>	TID prdsrT04
1.7.3.1	SR Instance Used		TID prdsrT04
1.10.3.1	SR Instance Used		Radiation Dose SR
1.10.3.1.1	SOP Class UID	1.2.840.1008.5.1.4.1.1.88.67	
1.10.3.1.2	SOP Instance UID	1.2.3.4.566.77.1	
1.7.3.1.1	Event UID Used	1.3.12.2.xxxxxx	TID prdsrT04
1.7.3.2	Patient Radiation Dose Model	<CONTAINER>	TID prdsrT04
1.7.3.2.1	Patient Model Type	(prdsrCD004, DCM, " Anthropomorphic Model ")	TID prdsrT04
1.7.3.2.2	Radiation Transport Model Type	(prdsrCD021, DCM, " Geometric Radiation Transport Model ")	TID prdsrT04
1.7.3.2.3	Patient Radiation Dose Model Data	< UID of " Patient Radiation Dose Model Data ">	TID prdsrT04
1.7.3.2.3	Patient Radiation Dose Model Data		Parametric map
1.7.3.2.3.1	SOP Class UID	1.2.840.1008.5.1.4.1.1.30	
1.7.3.2.3.2	SOP Instance UID	1.2.5.4.6.677	
1.7.3.2.4	Patient Radiation Dose Model Reference	Cristy et al. 1987	TID prdsrT04
1.7.3.2.5	Patient Model Demographics	<CONTAINER>	TID prdsrT04
1.7.3.2.5.1	Model Minimum Age	18 (a, UCUM, " year ")	TID prdsrT04
1.7.3.2.5.2	Model Maximum Age	18 (a, UCUM, " year ")	TID prdsrT04
1.7.3.2.5.3	Model Patient Sex	(M, DCM, " Male ")	TID prdsrT04
1.7.3.2.5.4	Model Minimum Weight	75 (kg, UCUM, " kilogram ")	TID prdsrT04

Node	Code Meaning of Concept Name	Code or Example Value	Comment
1.7.3.2.5.5	Model Maximum Weight	75 (kg, UCUM, "kilogram")	TID prdsrT04
1.7.3.2.5.6	Model Minimum Height	165 (cm, UCUM, "Centimeter")	TID prdsrT04
1.7.3.2.5.7	Model Maximum Height	165 (cm, UCUM, "Centimeter")	TID prdsrT04
1.7.3.2.6	Patient Model Registration	<CONTAINER>	TID prdsrT04
1.7.3.2.6.1	Registration Method	(125024, DCM, "Image Content-based Alignment")	TID prdsrT04
1.7.3.2.6.2	Spatial Registration	<UID of "Spatial Registration">	TID prdsrT04
1.7.3.2.6.2.1	SOP Class UID	1.2.840.1008.5.1.4.1.1.66.1	
1.7.3.2.6.2.2	SOP Instance UID	1.4.9.87.11.223.5	
1.7.3.3	X-ray Beam Attenuator	<CONTAINER>	TID prdsrT04
1.7.3.3.1	Attenuator Category	(113771, DCM, "X-Ray Filters")	TID prdsrT04
1.7.3.3.2	Equivalent Attenuator Material	(C-120F9, SRT, "Aluminum or Aluminum compound")	TID prdsrT04
1.7.3.3.3	Equivalent Attenuator Thickness	1.4 (mm, UCUM, "Millimeter")	TID prdsrT04
1.7.3.3.4	Attenuator Description	Mean equivalent Aluminum thickness of bowtie filter	TID prdsrT04
1.7.3.3.5	X-ray Beam Attenuator Model	<CONTAINER>	TID prdsrT04
1.7.3.3.5.1	Radiation Transport Model Type	(prdsrCD021, DCM, "Geometric Radiation Transport Model")	TID prdsrT04
1.7.3.4	Radiation Dose Estimate Method	<CONTAINER>	TID prdsrT04
1.7.3.4.1	Radiation Dose Estimate Method Type	(D009010, MSH, "Monte Carlo")	TID prdsrT04
1.7.3.4.2	Radiation Dose Estimate Parameters	<CONTAINER>	TID prdsrT05
1.7.3.4.2.1	(111634, DCM, "Half Value Layer")	8.5 (mm, UCUM, "Millimeter")	TID prdsrT05
1.7.3.4.3	Radiation Dose Estimate Method Reference	Simulation package XX version YY	TID prdsrT04
1.7.4	Radiation Dose Estimate Representation	<CONTAINER>	TID prdsrT03
1.7.4.1	Distribution Representation	(prdsrCD096, DCM, "Dose Point Cloud")	TID prdsrT03
1.7.4.2	Radiation Dose Representation Data		TID prdsrT03
1.7.3.2.3.1	SOP Class UID	1.2.840.1008.5.1.4.1.1.30	Parametric Map

Supplement 191: Patient Radiation Dose SR (PRDSR)
Page 44

Node	Code Meaning of Concept Name	Code or Example Value	Comment
1.7.3.2.3.2	SOP Instance UID	1.87.2.3.4.11.3	
1.7.4.3	Organ	(T-D0010, SRT, "Entire Body")	TID prdsrT03
1.7.5	Organ Radiation Dose Information	<CONTAINER>	TID prdsrT02
1.7.5.1	Organ	(T-28000, SRT, "Lung")	TID prdsrT02
1.7.5.1.1	(DCM, Prdsrxxx3, "Mean Absorbed Radiation Dose")	9.6 (mGy, UCUM, "mGy")	TID prdsrT02